



Тел: +7 495 7907870
Моб: +7 965 4429948
Skype: Discoverytelecom
Mail: info@discoverytelecom.ru
www.discoverytelecom.ru



Alfacom AUDIO-VIDEO DOOR ENTRY SOLUTIONS

Made in the Czech Republic, EU since 1999
SIP VoIP – GSM – PSTN analogue



Production according to ISO 9001:2001 standards

PCB boards produced in a PCB assembly center in Blansko, the Czech Republic

- Assembling, Soldering, Burn-in, Quality control

Equipment examples:

- Assembly - three high precision machines with on-the-fly components testing (MYDATA)
- Solder paste and glue printing - screen printing laser-etched stencils (MPM ACCUFLEX)
- Solder paste reflow - Hot Air Reflow oven (HELLER) and Vapour Phase Reflow (ASSCON)
- Classic soldering - two wave solder machines with spraying fluxer and double-wave system (SEHO)
- Quality control – X-ray inspection system at submicron resolution with CT capabilities (NIKON)



Alfacom product portfolio

GSM-UMTS routers



VoIP SIP - GSM



EuroISDN - GSM

Audio-video doorphones



Audio - video VoIP SIP



Audio - video analog

Lift Communicators



Link Lift Watch analog



GSM Lift Watch

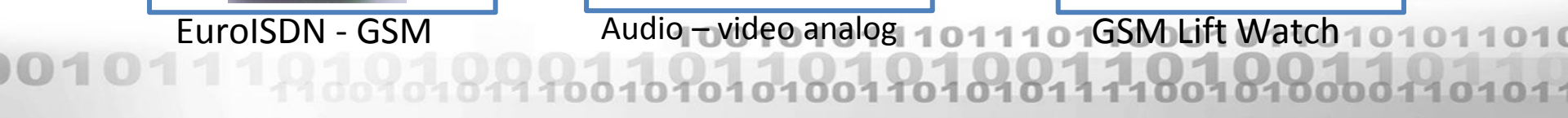

Alfacom GSM-UMTS routers

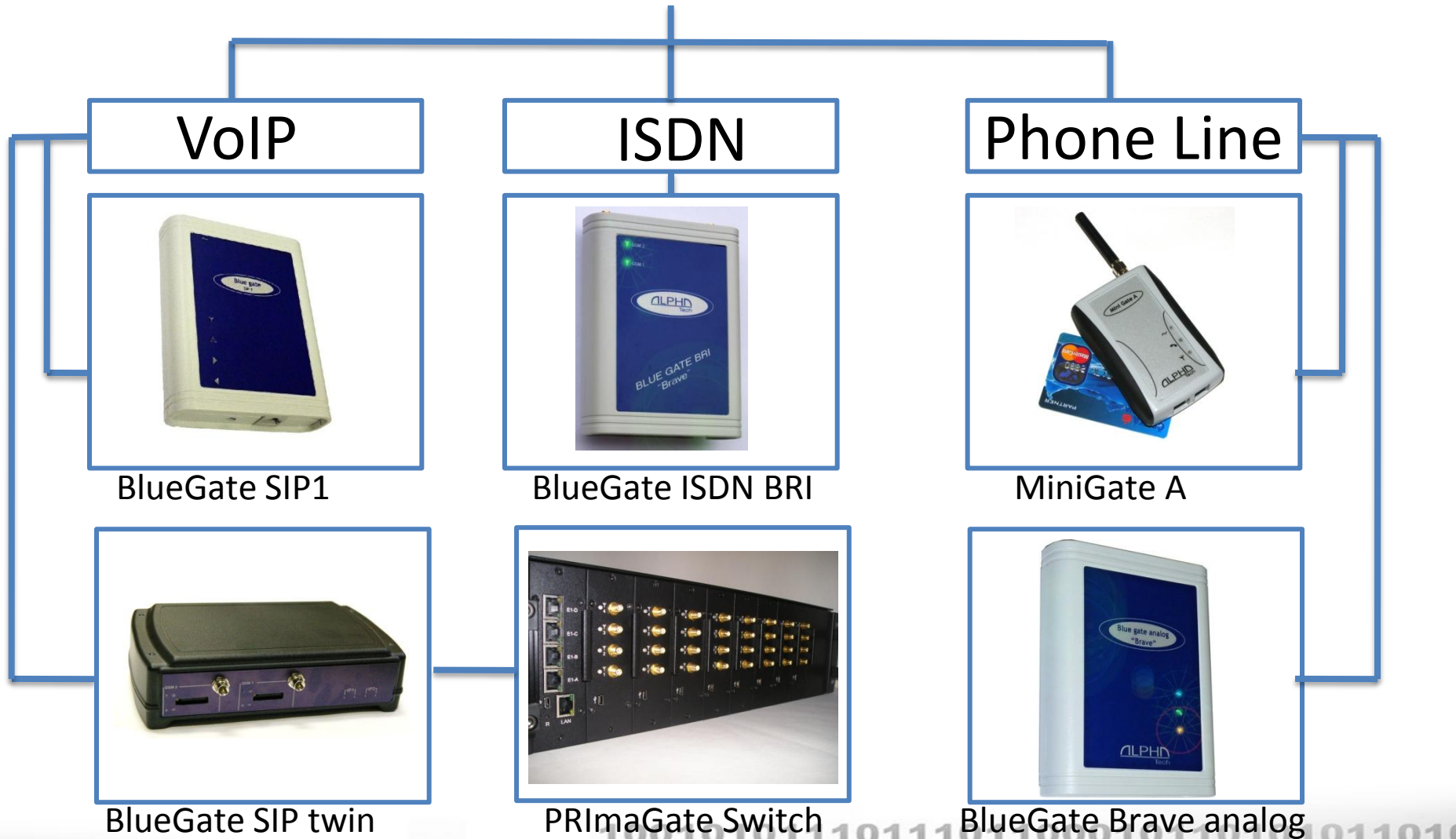



Alfacom SMS-Mail server SW application compatible with all
Alfacom GSM-UMTS routers

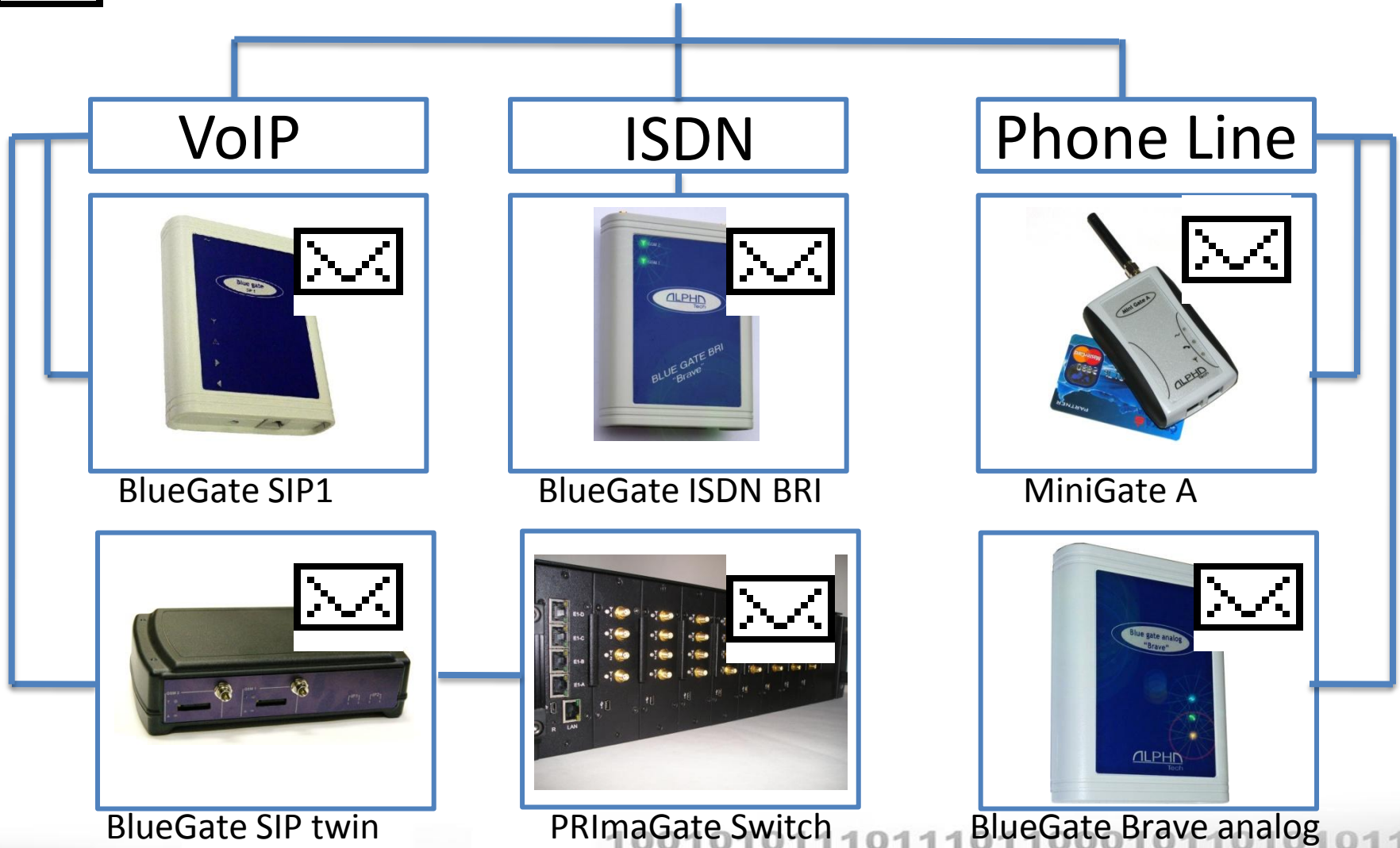

Alfacom audio-video door entry phones

VoIP



IP Bell video

GSM



GDI Bell

Phone Line



A-Bell video analog



IP Bell audio



Bell rain hoods and boxes



A-Bell audio analog



Alfacom audio-video door entry phones

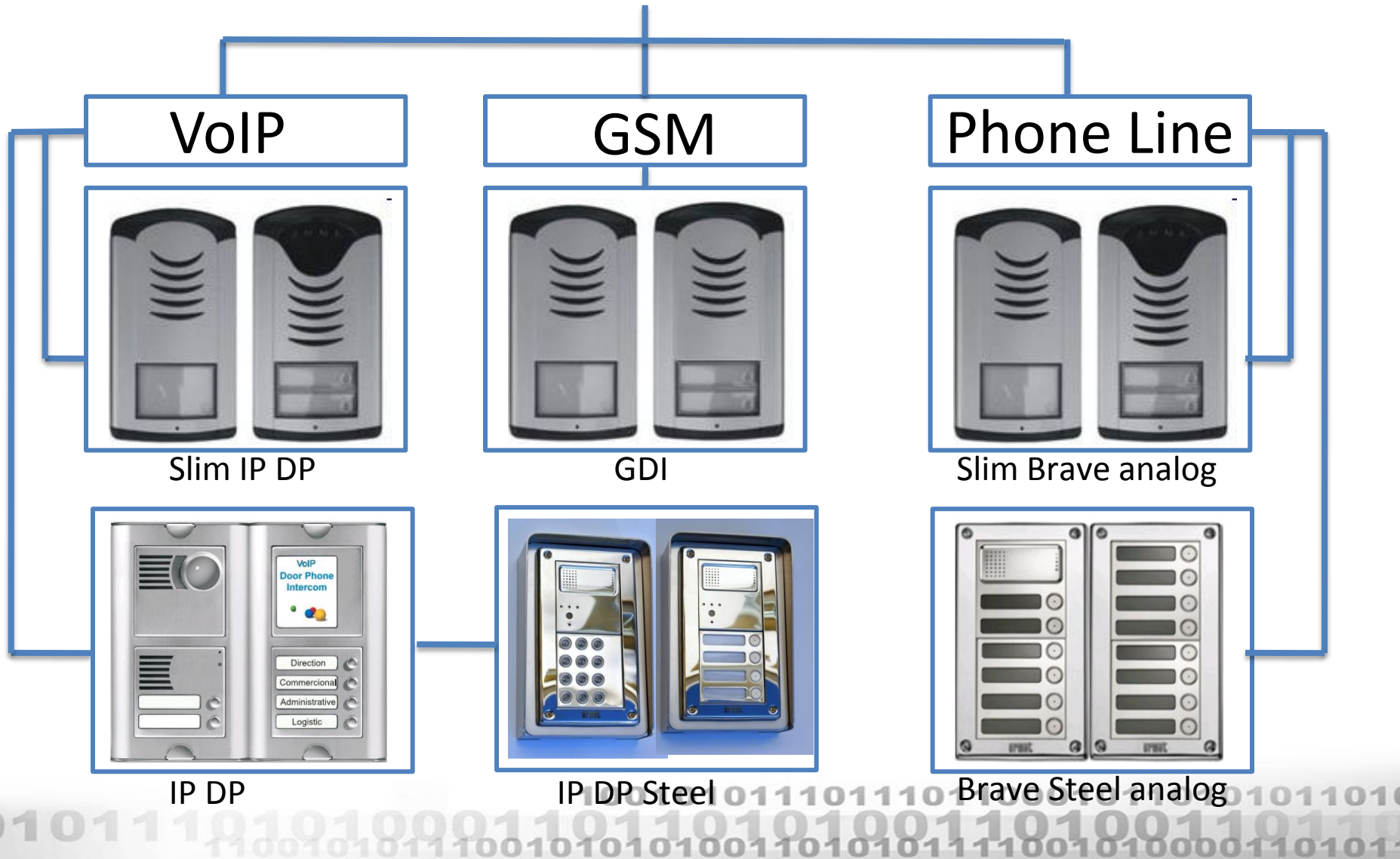

Alfacom audio-video door entry phones

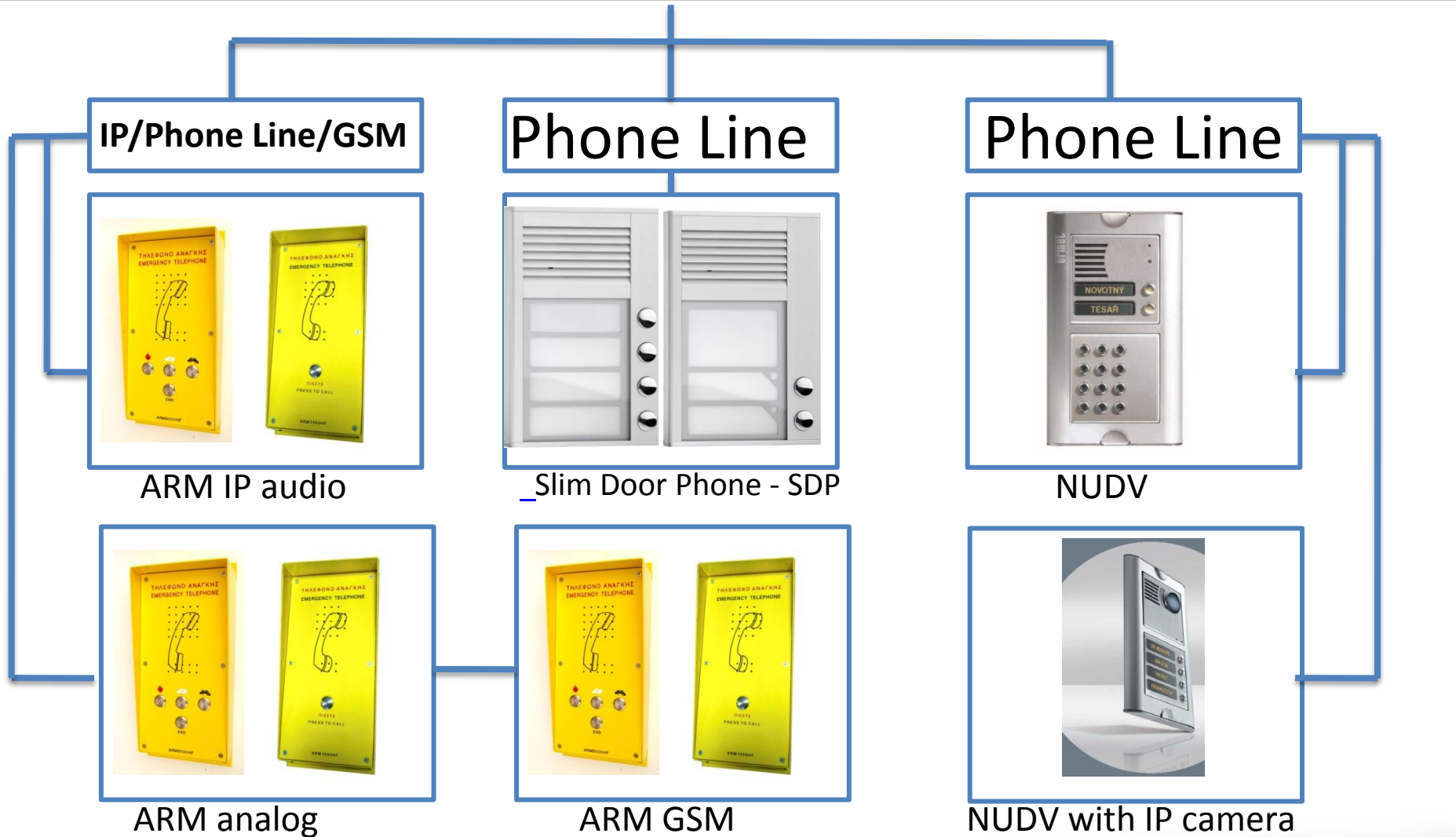

1001010111011101100010110101011010
010111010100011011010100110100110110
110010101110010101010011010101111001010000110101

Alfacom audio-video door entry accessories

Phone Exchange



Small Exchange for Doorphone

Relay Switch

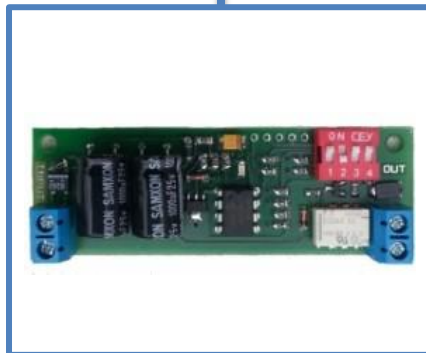

Code Switch for higher safety

Relay Switch



Line DIN switch 4 relays



Odysus 1 / 4 PABX

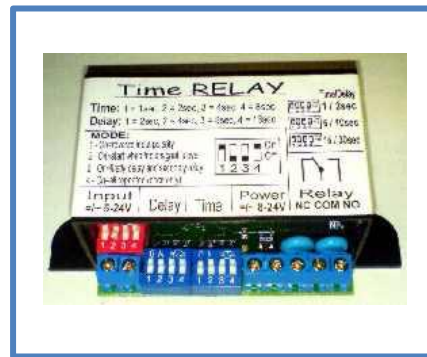

Time Relay



Code keyboard



Analog Slim Door Phone - SDP



16mm slim analog audio doorphone system allows available in versions:

- 1, 2 or 4 call buttons – SDP01, SDP02, SDP04
- Dialling keypad module with up to 10 access codes / Independent code keypad module with additional relay contact / Exit button

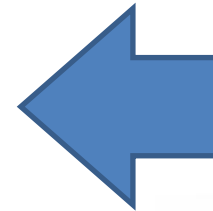

SDP01 with dialling keypad



Analog Slim Door Phone - SDP

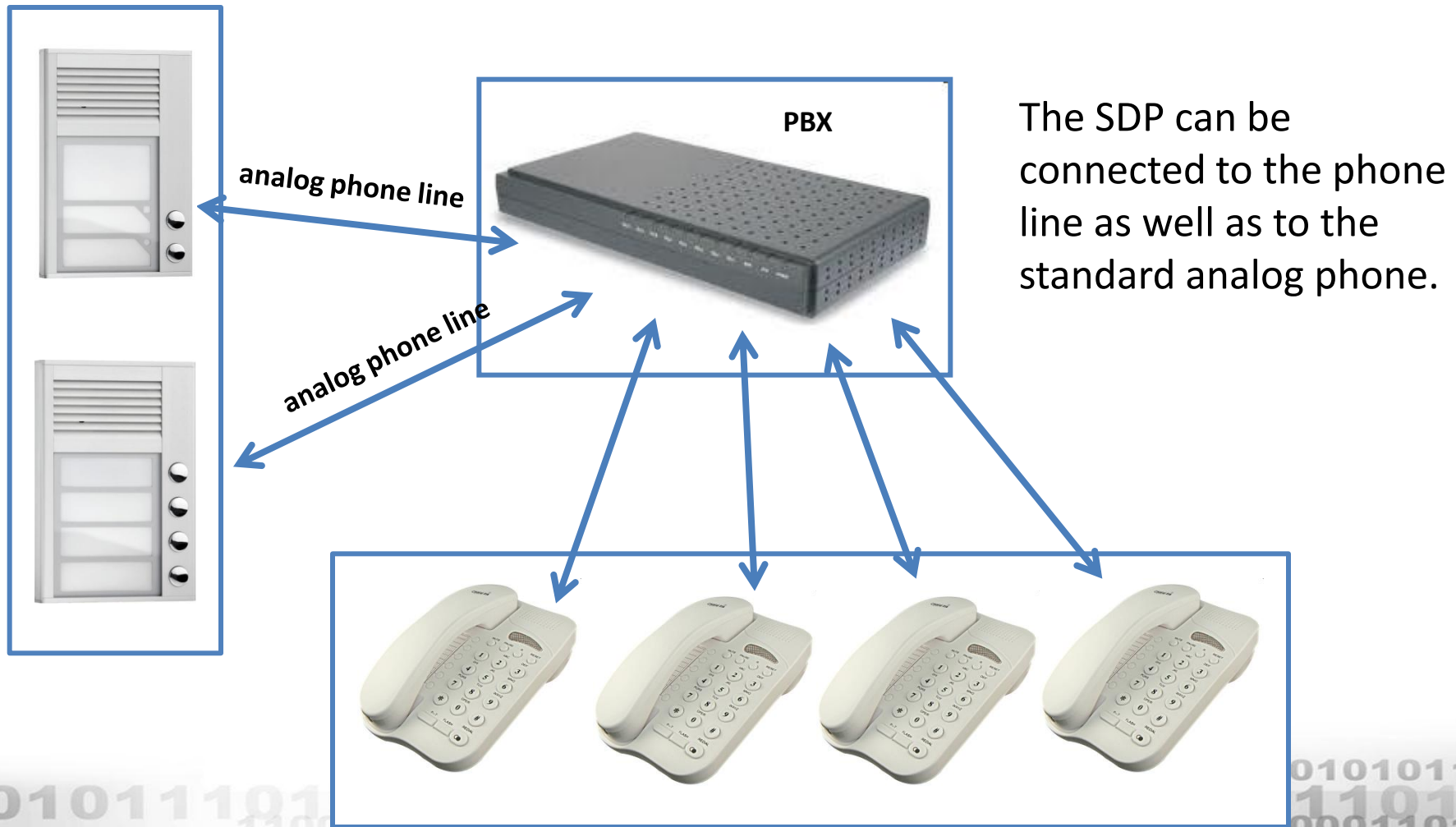

Analog Slim Door Phone - SDP

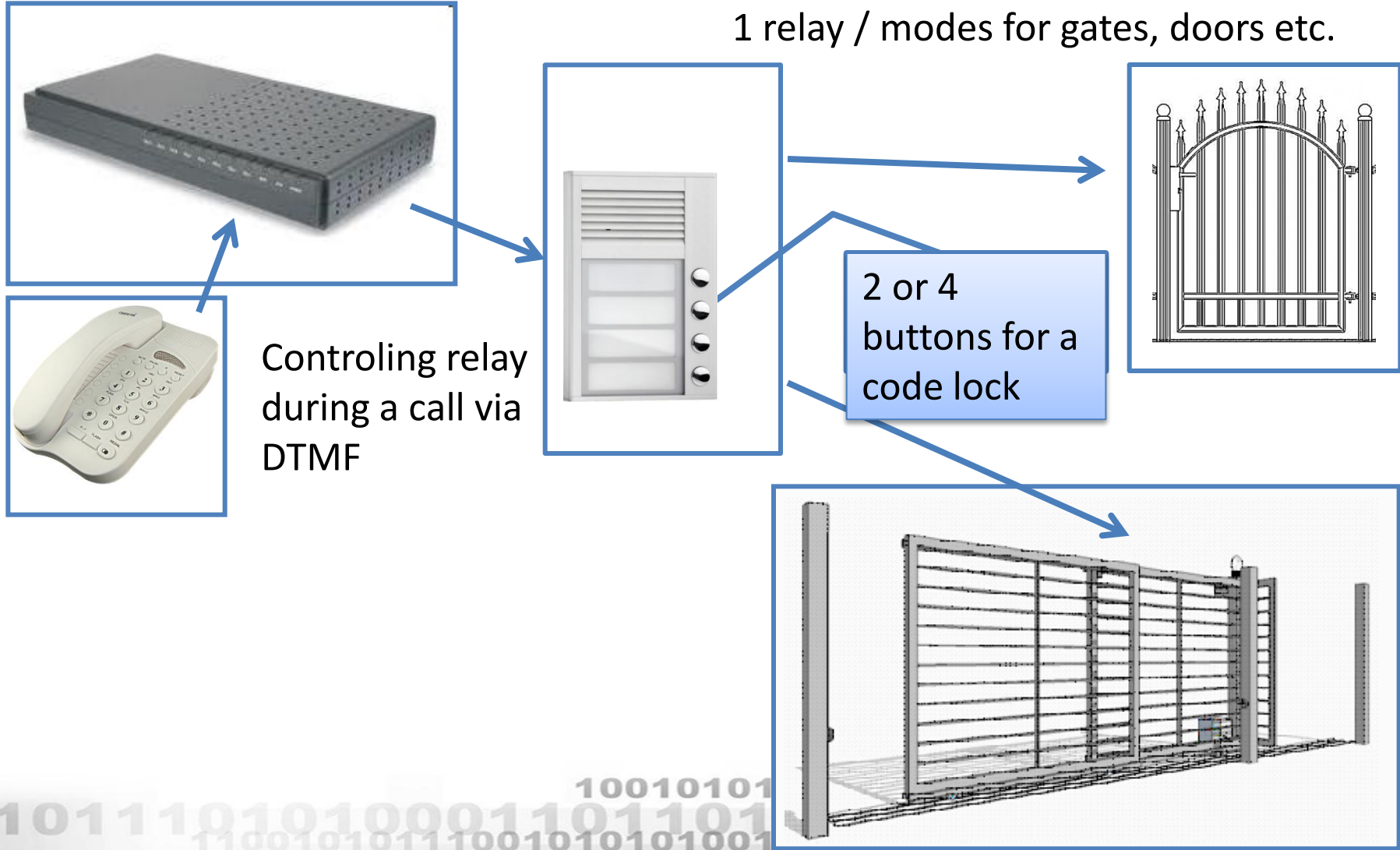

001011 101010001101101
110010101110010101001

Analog Slim Door Phone - SDP

The SDP behaves as a regular analog phone – it is powered from the telephone line and does not require external power.

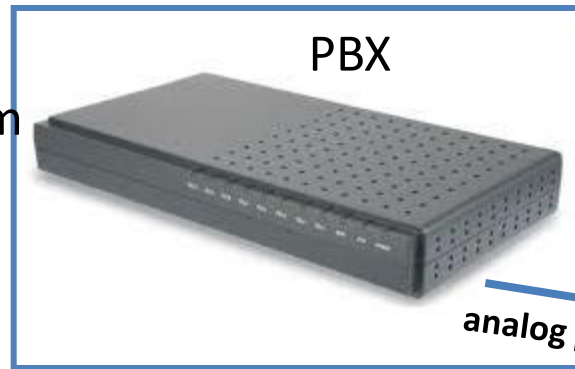

analog phone line →



When using an electric lock, the SDP requires an external power supply. In this case the SDP is powered from this source - it does not need permanent voltage on the telephone line.



Analog Slim Door Phone - SDP

All parameters of the SDP can be configured:

By program from PC

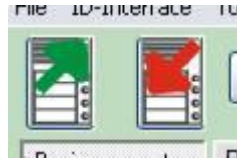

USB cable

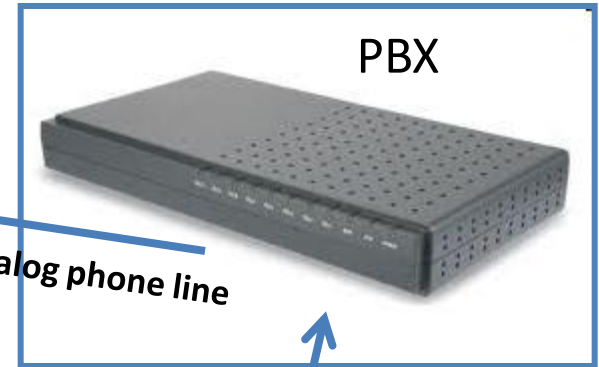

PBX

analog phone line

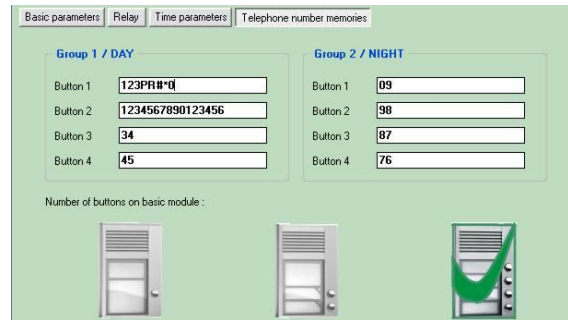

During a call via DTMF



Small Exchange for Doorphone – SED-111

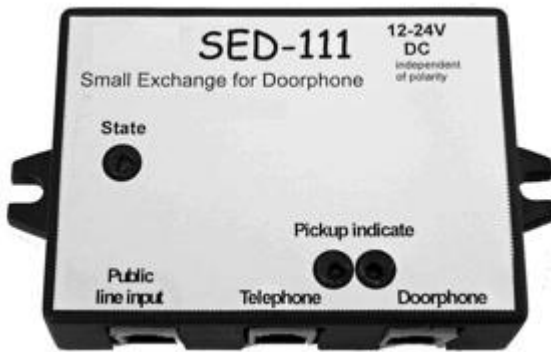
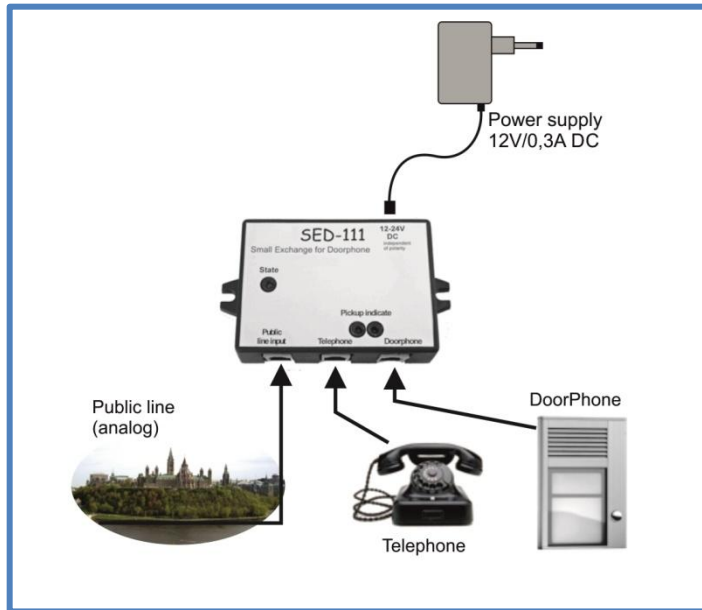

SED-111

- Small Exchange for Doorphone SED-111 is a simple connection device that allows to connect a doorphone between the existing analog phone line and the analog telephone.

- SED-111 is mainly determined for use in a small house or apartment where you can connect a doorphone easily.

- SED-111 allows communication of a phone with the public line and voice communication with the doorphone at the door entrance.

- It also allows to program parameters in the doorphone.

A-Bell Analog Door Phone



Modular audio-video system allows to connect:

- 1 to 98 buttons
- analog camera
- RFID



Bell doorphone demo case

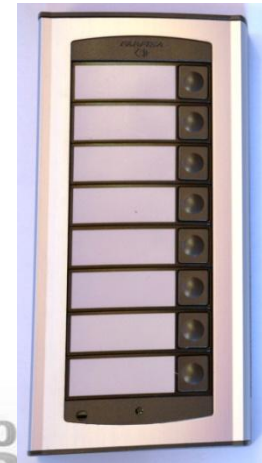

A-Bell Analog Door Phone



- 1, 2 or up to 98 push buttons
- with or without analog camera

In the memory of each button there can be stored 2 phone numbers.

- Telephone number for the day / telephone number for the night (mode can be switched manually or automatically according to the time server on the Internet).

- By pressing the same button once again, the second number in the sequence is dialed.

- The second number is also automatically dialed if the called party is busy or does not respond.



A-Bell Analog Door Phone

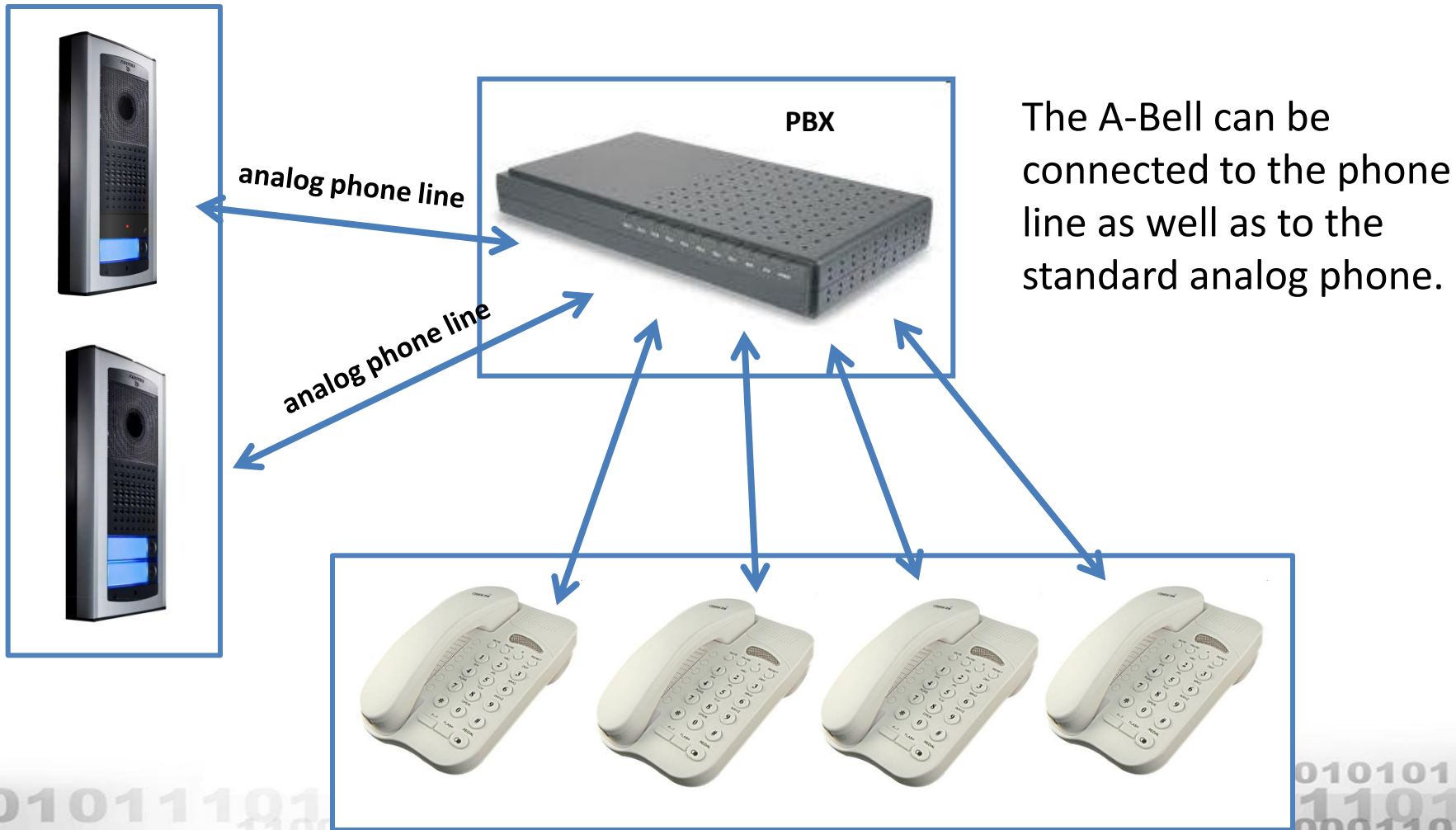

A-Bell Analog Door Phone



PAL video 1V / 75ohm



Analog camera with continuous or automatic operation - camera is only active when the A-Bell is activated.



A-Bell Analog Door Phone

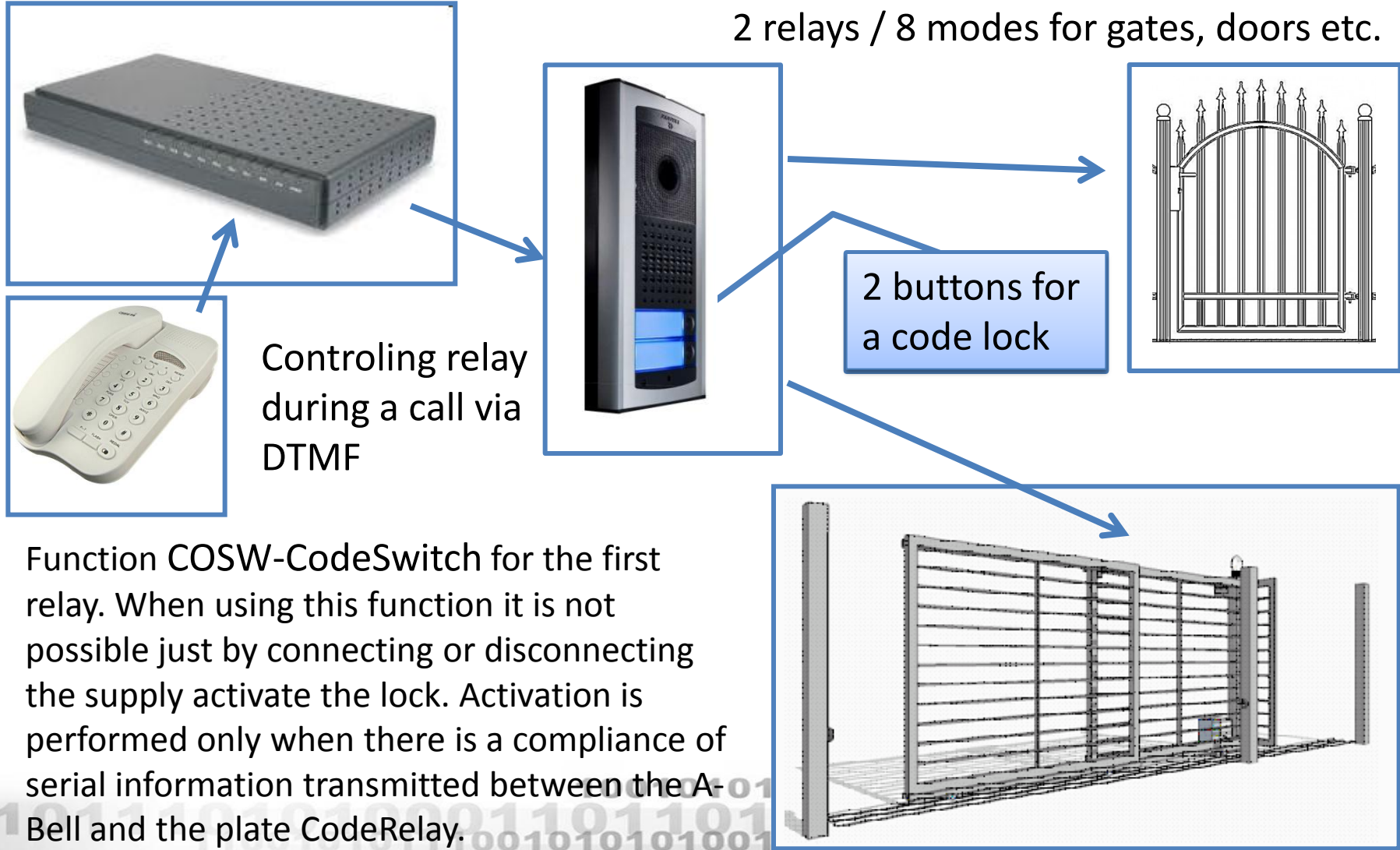

2 relays / 8 modes for gates, doors etc.

Controlling relay during a call via DTMF

2 buttons for a code lock

Function COSW-CodeSwitch for the first relay. When using this function it is not possible just by connecting or disconnecting the supply activate the lock. Activation is performed only when there is a compliance of serial information transmitted between the A-Bell and the plate CodeRelay.

A-Bell Analog Door Phone

The A-Bell behaves as a regular analog phone – it is powered from the telephone line and does not require external power.

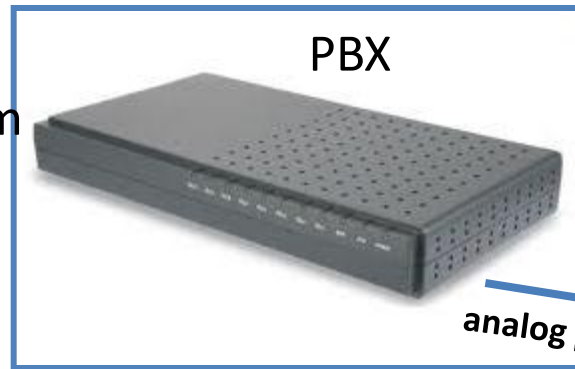

analog phone line →



When using electric locks, the A-Bell requires an external power supply. In this case the A-Bell is powered from this source - it does not need permanent voltage on the telephone line.



A-Bell Analog Door Phone

All parameters of the A-Bell can be configured:



USB cable



By program from PC

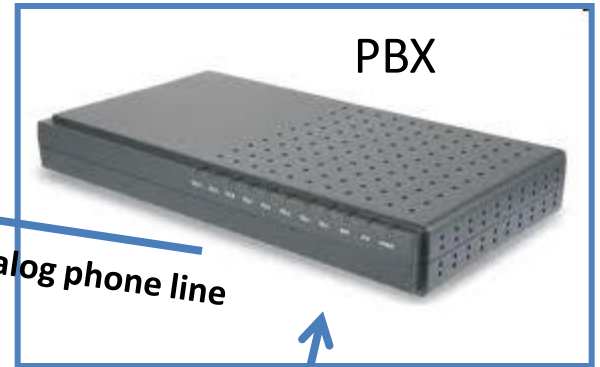

PBX

analog phone line



During a call via DTMF



A-Bell Analog Door Phone

Bell doorphone accessories

- Surface rain hood
- Flush mounting installation box into the wall
- Flush mounted installation box with a rain hood into the wall

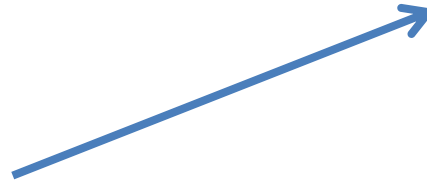

01010111011101100010110101011010
010111010100011011010100110100110110
110010101110010101010011010101111001010000110101

GDI Bell - GSM Door Intercom

1 or 2 push buttons



In the memory of each button there can be stored up to seven phone numbers in the sequence. After pressing a button, GDI Bell dials the first phone number. If within a certain time there is no answer, i.e.

- the call is rejected
 - the subscriber is unavailable
 - the subscriber does not answer
- then the GDI Bell dials the next phone number in the stored sequence.

1001010111011101100010110101011010
0010111010100011011010100110100110110
1100101011100101010100110101011110010100001101011

GDI Bell - GSM Door Intercom

Incoming calls can be:

- all rejected
- all automatically received
- only calls from the list of phone numbers stored in the memory of GDI Bell can be received automatically



GDI Bell - GSM Door Intercom

2 relays, 4 modes

Gates, doors can be opened (close output relay) by:

- an unanswered call from predefined phone numbers (free of charge ring)
- sending a defined DTMF code (by pressing a defined button on the phone's keypad) during a call
- SMS text from defined phone numbers



GDI Bell can send SMS text with the telephone number from which the opening was activated and the date and time of opening.



001011110101000110011010101110010100001101011010101110111011101100010110101011010

GDI Bell - GSM Door Intercom

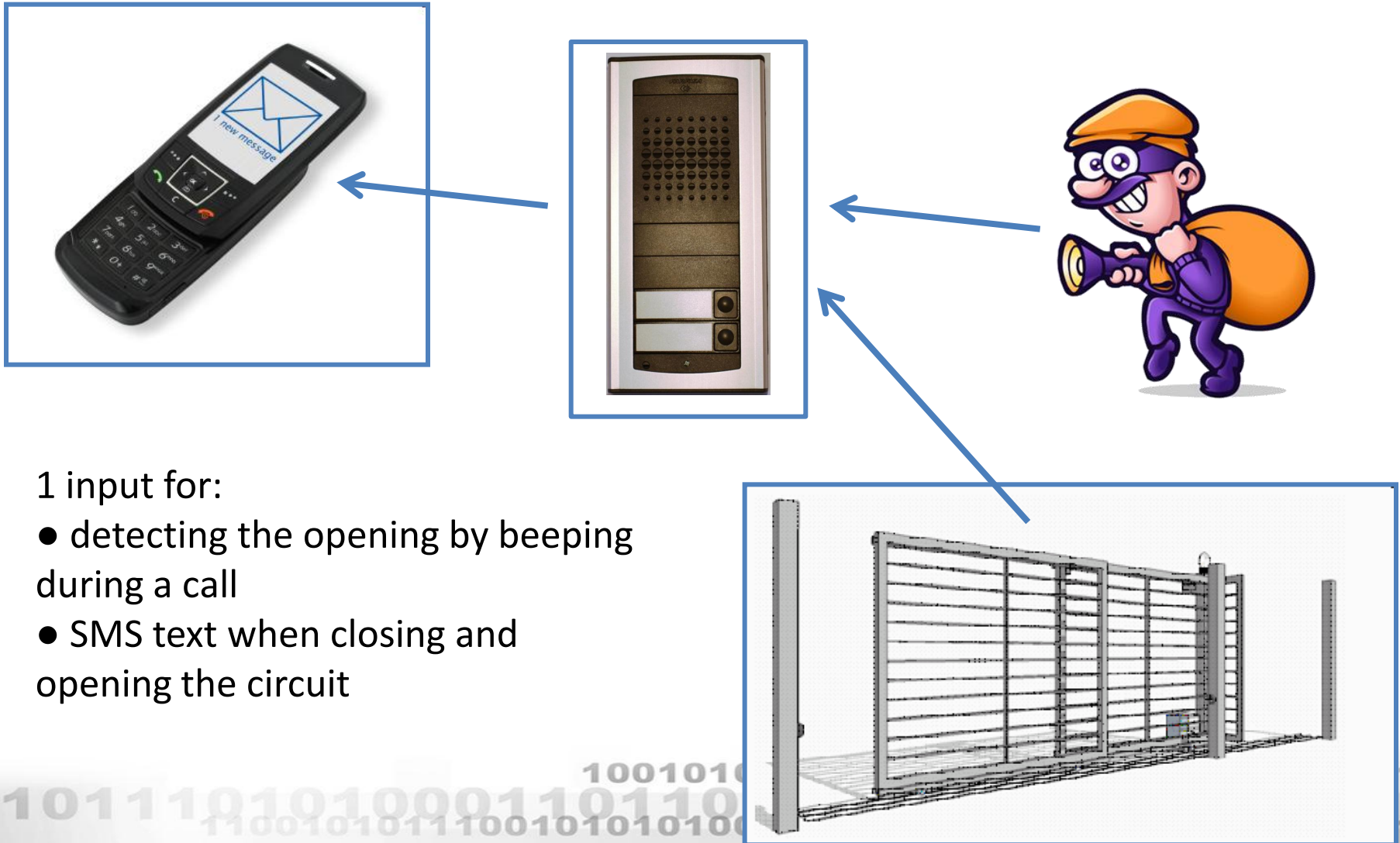

1 input for:

- detecting the opening by beeping during a call
- SMS text when closing and opening the circuit

GDI Bell - GSM Door Intercom



It's open,
please come in

All the important states and actions, i.e.

- standby
 - dialing
 - incorrect PIN
 - not logged into the network
 - error
 - open (relay on)
- etc.

are commented by voice messages.

00101111010100011011010100110100110110
11001010111001010100110101011110010100001101011

GDI Bell - GSM Door Intercom

backup battery

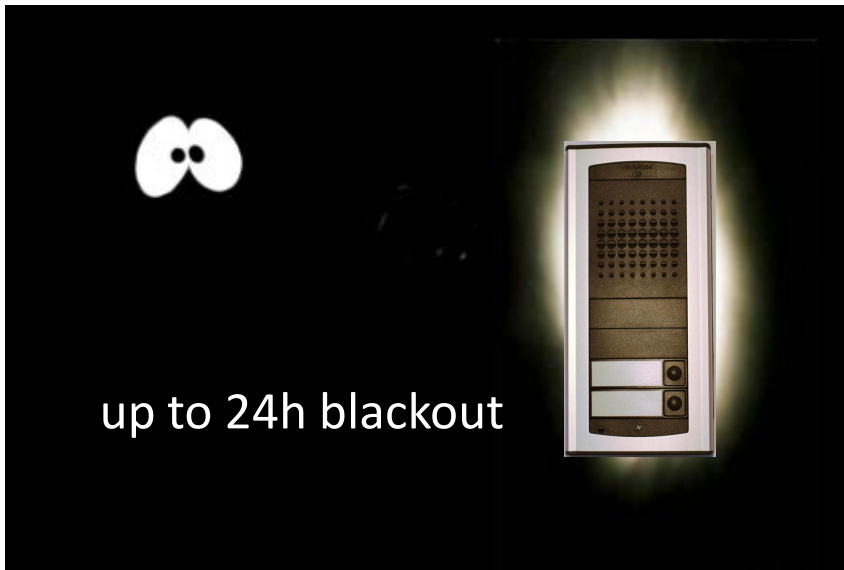

Power supply by solar batteries



GDI Bell - GSM Door Intercom

3 possibilities (ways) of parameter setting

Direct programming of the GDI's SIM card in a standard mobile phone.

Via the program from the PC.

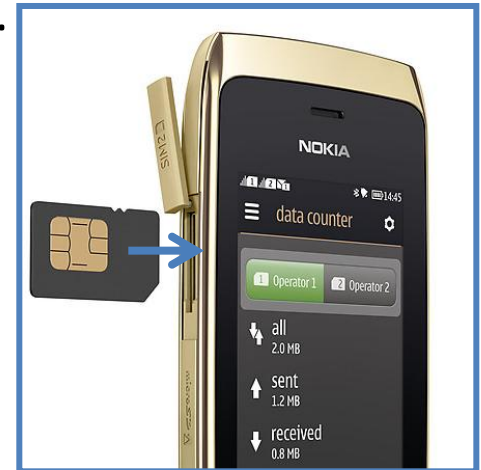
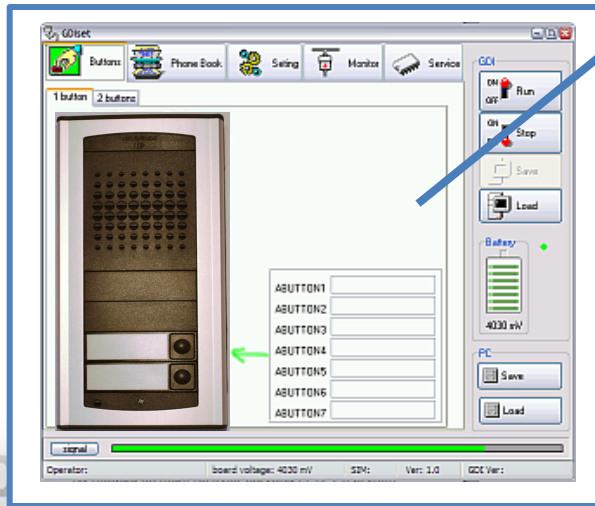

Using the setting text SMS messages from defined phone numbers.

GDI Bell - GSM Door Intercom

Bell doorphone accessories

- Surface rain hood
- Flush mounting installation box into the wall
- Flush mounted installation box with a rain hood into the wall

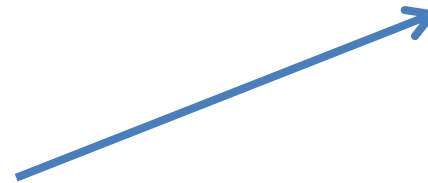

01010111011101100010110101011010
010111010100011011010100110100110110
1100101011100101010011010101111001010000110101

IP Bell VoIP/SIP Door Phone



- 1, 2 or up to 56 call buttons
- with or without IP camera
- optional RFID reader/controller

In the memory of each button there can be stored 2 phone numbers (IP addresses).

6-digit access code(s) for direct opening of the door.

- Telephone number for the day / telephone number for the night (mode can be switched manually or automatically according to the time server on the Internet).
- Again by pressing the same button, the second number is dialled in the sequence.



IP Bell VoIP/SIP Door Phone

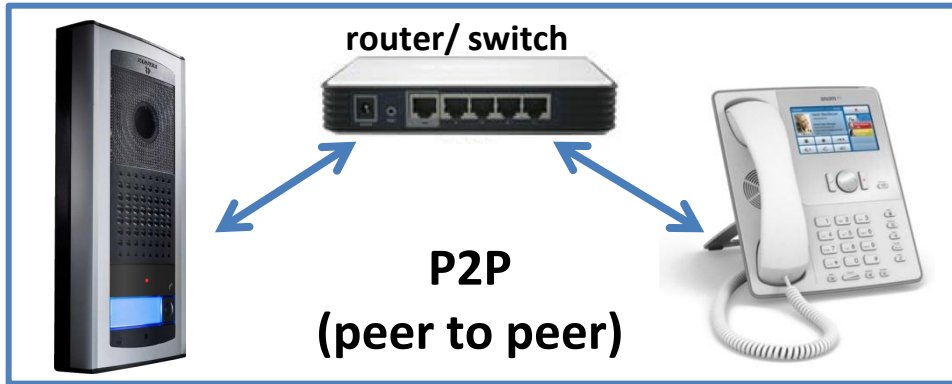

IP Bell allows the connection to the Ethernet via P2P (peer to peer) protocol and also via SIP proxy

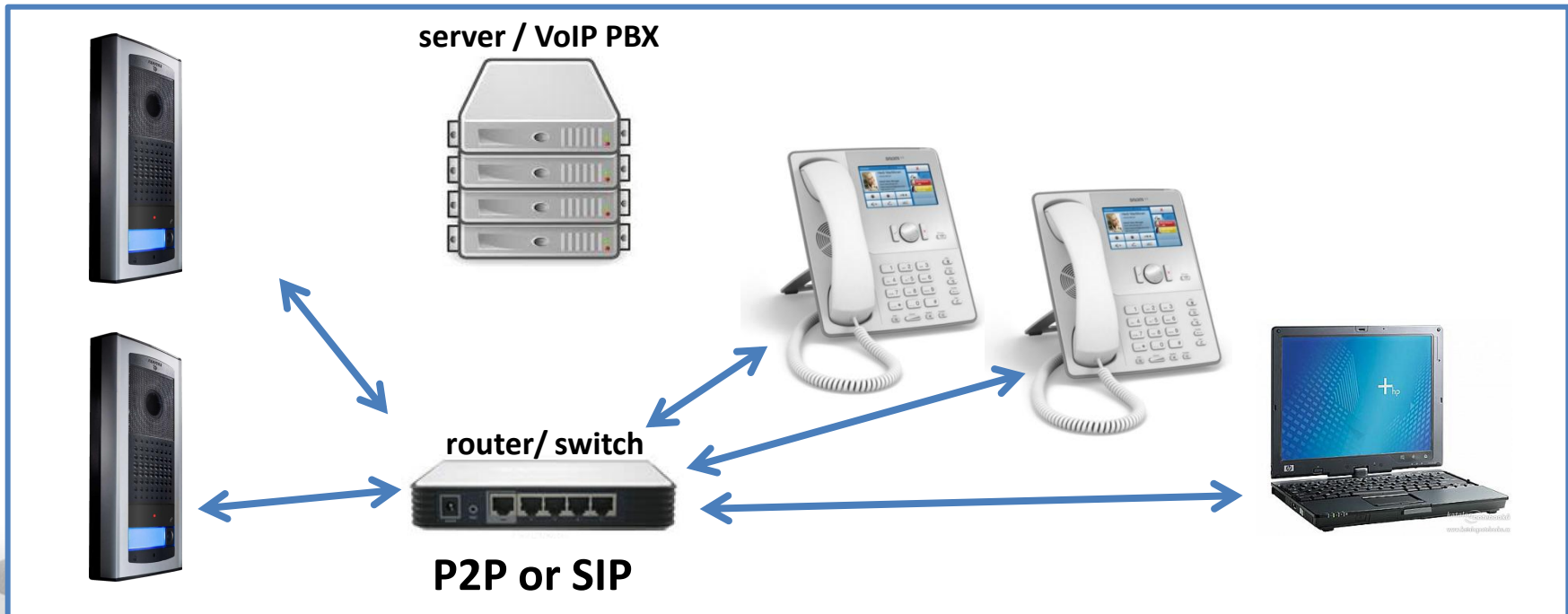

11010
1101
01011

IP Bell VoIP/SIP Door Phone

IP Bell enables, in addition to the normal VoIP phone talk, watching the video stream of a colour, built-in camera and operate opening locks (relays) via applications for

- Windows PC
- iPhone/iPad
- Android



IP Bell VoIP/SIP Door Phone

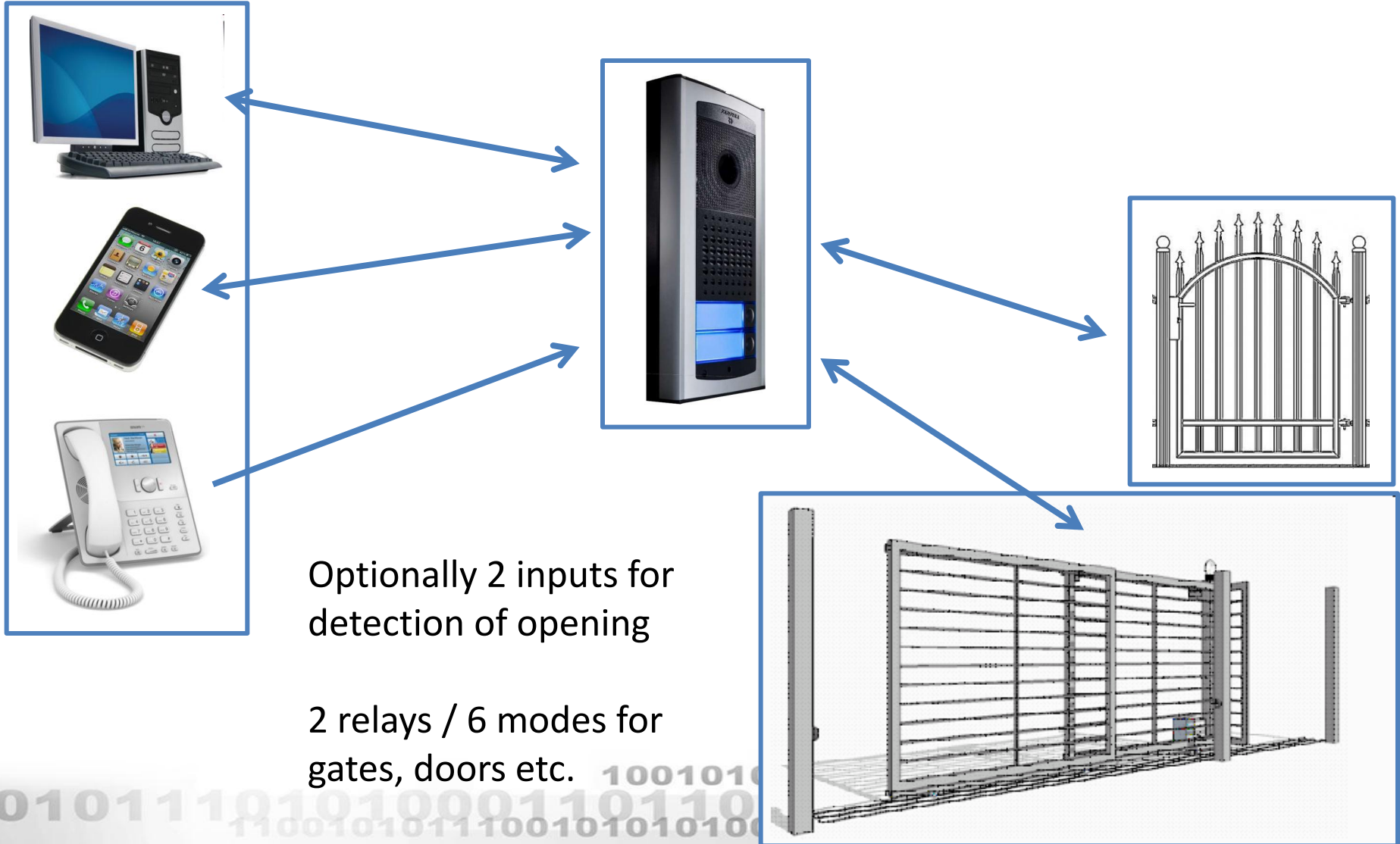

IP Bell VoIP/SIP Door Phone

IP Bell can be powered directly via Ethernet (PoE).

POE switch



low (consumption)
power locks



When IP Bell is used with electric locks, it can be powered from the same power supply.



power supply 12V



IP Bell VoIP/SIP Door Phone

Setting of all parameters can be done remotely via a http web interface (any web client) after login via name and password.

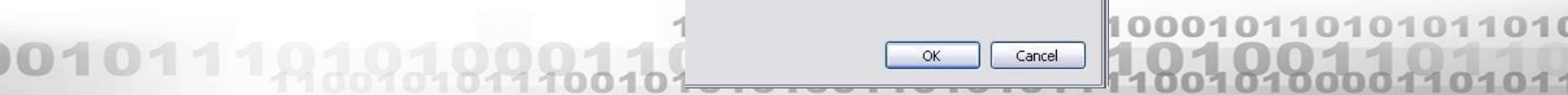
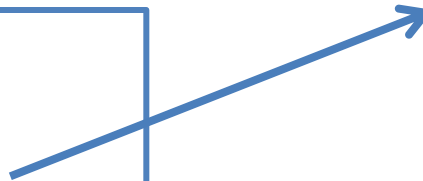

IP Bell VoIP/SIP Door Phone

RFID (HID/EM Marin 125kHz) – by using APSLAN ETH/RS485 convertor, setting of all parameters can be done remotely via APS Home SW (part of delivery of RFID system).

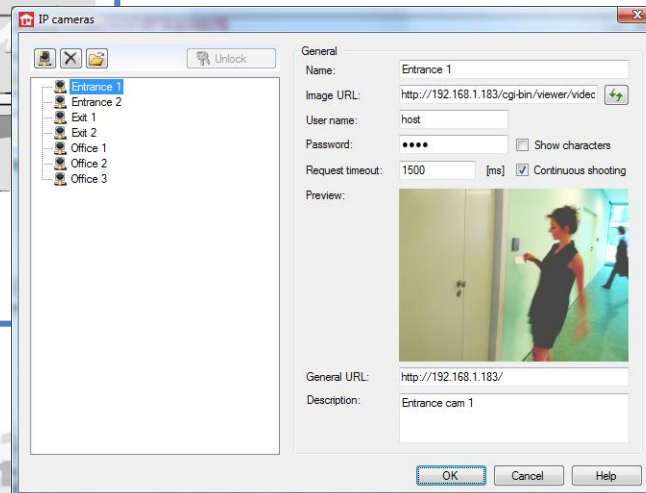
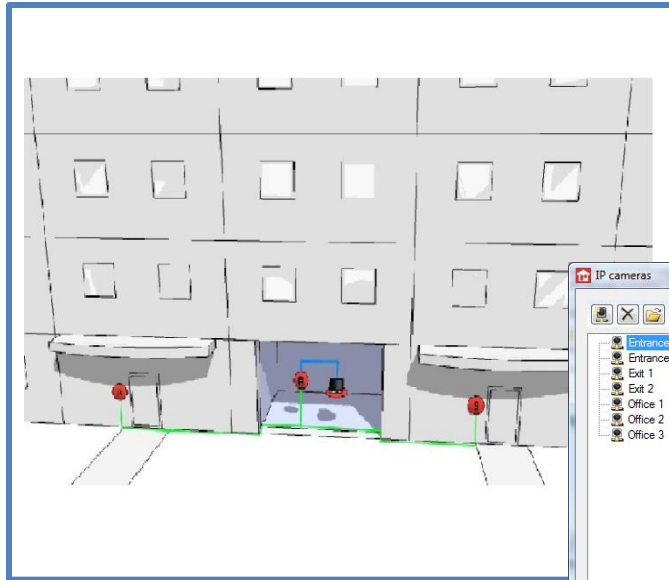

IP Bell VoIP/SIP Door Phone

RFID – events archive

Store all important data on all events of RFID enabled VoIP video doorphones including images (snapshots) from a camera of the doorphone and external cameras

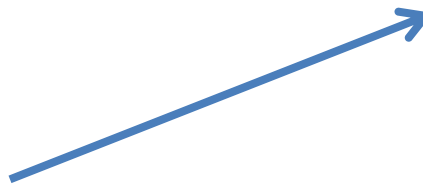
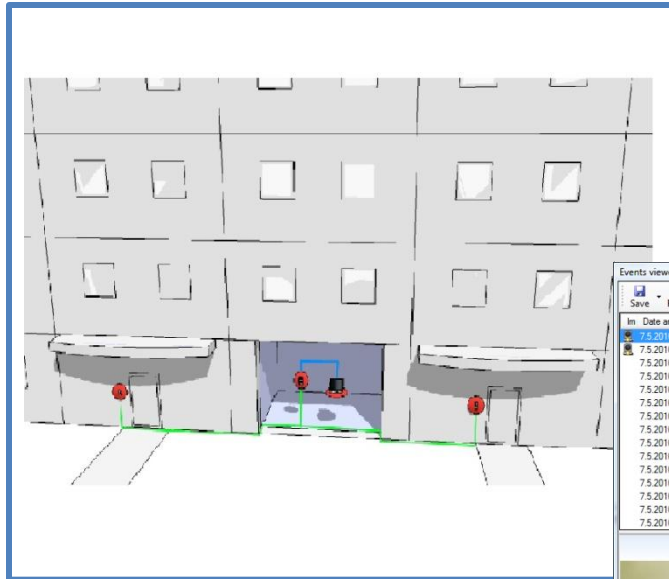

Events viewer

In	Date and time	Area	Module	Event	User	Access card	Key code
	7.5.2010 9:14:24	Area 1	02 - New module	Unknown ID	-	[000000014B65...	255
	7.5.2010 9:14:20	Area 1	02 - New module	Remote configura...	-	-	0
	7.5.2010 9:14:20	Area 1	04 - New module	Remote configura...	-	-	0
	7.5.2010 9:14:20	Area 1	03 - New module	Remote configura...	-	-	0
	7.5.2010 9:14:20	Area 1	01 - New module	Remote configura...	-	-	0
	7.5.2010 9:14:18	Area 1	02 - New module	Strike closed	-	-	0
	7.5.2010 9:14:11	Area 1	02 - New module	Strike released	-	-	0
	7.5.2010 9:14:11	Area 1	02 - New module	Remote door ope...	-	-	0
	7.5.2010 9:14:08	Area 1	03 - New module	Remote door ope...	-	-	0
	7.5.2010 9:14:04	Area 1	01 - New module	Strike closed	-	-	0
	7.5.2010 9:14:02	Area 1	04 - New module	Remote door ope...	-	-	0
	7.5.2010 9:13:57	Area 1	01 - New module	Strike released	-	-	0
	7.5.2010 9:13:57	Area 1	01 - New module	Remote door ope...	-	-	0
	7.5.2010 9:13:53	Area 1	04 - New module	Remote configura...	-	-	0

Entrance_1 7.5.2010 9:14:31

Entrance_2 7.5.2010 9:14:31

Two video snapshots showing a woman in a black dress using a doorphone. The first snapshot shows her from the side, holding the device to her ear. The second snapshot shows her from the front, holding the device to her ear.

1/1 Records: 85. Days: 14. Criteria: (none).



IP Bell VoIP/SIP Door Phone

Bell doorphone accessories

- Surface rain hood
- Flush mounting installation box into the wall
- Flush mounted installation box with a rain hood into the wall

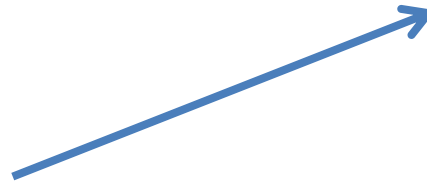

01010111011101100010110101011010
010111010100011011010100110100110110
1100101011100101010011010101111001010000110101

Slim VoIP/SIP Door Phone



- 1 or 2 call buttons
- optional RFID with recording of images
- with or without IP camera
- optional vandal-proof housing

In the memory of each button there can be stored 2 phone numbers (IP addresses).

6-digit access code(s) for direct opening of the door.

- Telephone number for the day / telephone number for the night (mode can be switched manually or automatically according to the time server on the Internet).
- Again by pressing the same button, the second number is dialled in the sequence.



Slim VoIP/SIP Door Phone

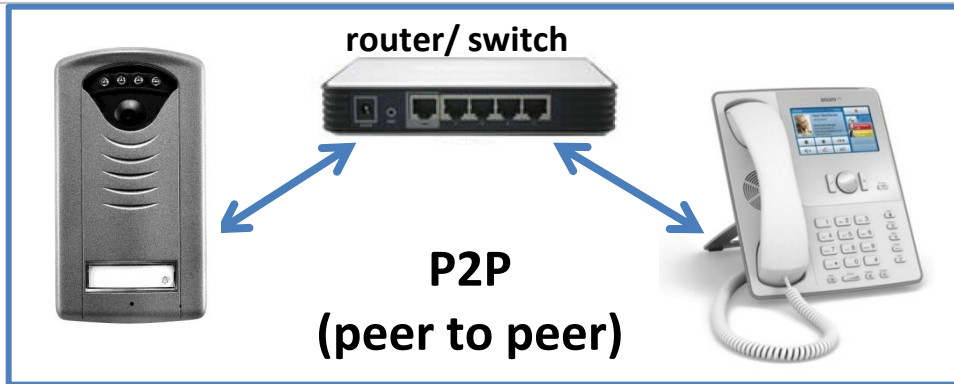

Slim IP DP allows the connection to the Ethernet via P2P (peer to peer) protocol and also via SIP proxy

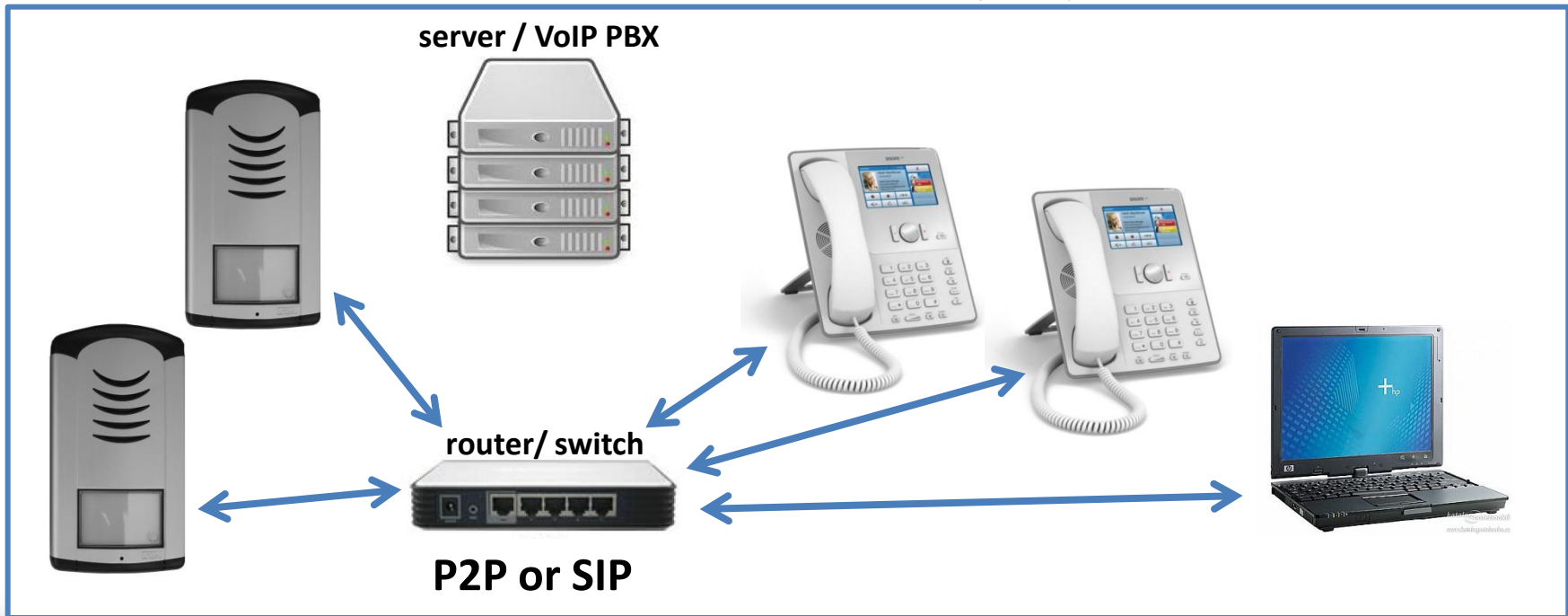

Slim VoIP/SIP Door Phone

Slim IP DP enables, in addition to the normal VoIP phone talk, watching the video stream of a colour, built-in camera and operate opening locks (relays) via applications for

- Windows PC
- iPhone/iPad
- Android



Slim VoIP/SIP Door Phone

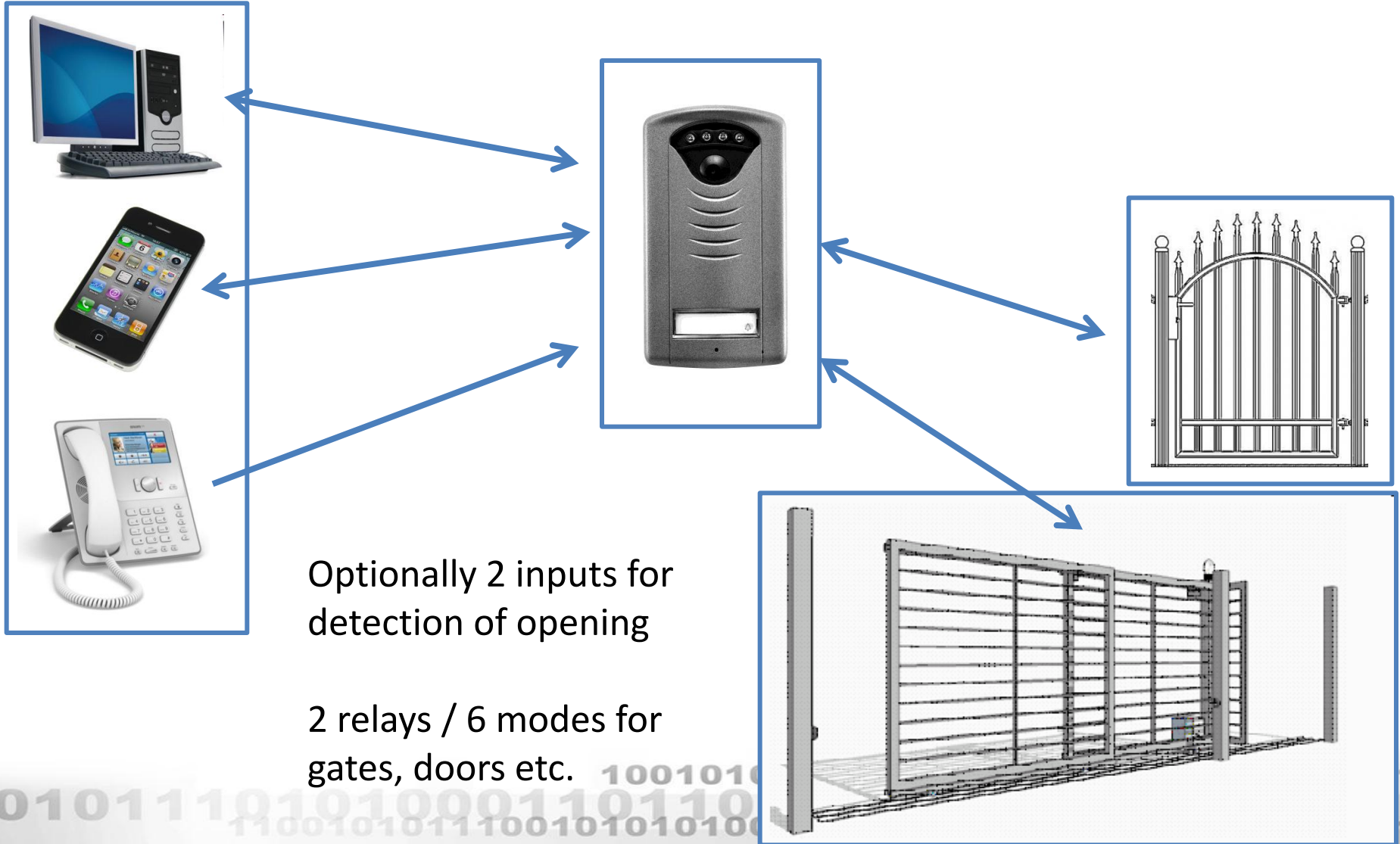

Slim VoIP/SIP Door Phone

Slim IP DP can be powered directly via Ethernet (PoE).

POE switch



low (consumption) power locks



When Slim IPDP is used with electric locks, it can be powered from the same power supply.

power supply 12V



Slim VoIP/SIP Door Phone

Setting of all parameters can be done remotely via a http web interface (any web client) after login via name and password.

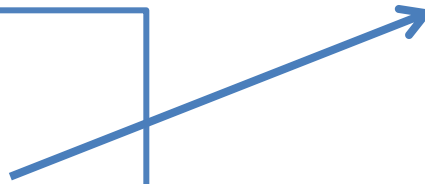

Connect to 207.41.121.82



User name:

Password:

Remember my password

OK Cancel



Slim VoIP/SIP Door Phone

RFID (HID/EM Marin 125kHz) – by using APSLAN ETH/RS485 convertor, setting of all parameters can be done remotely via APS Home SW (part of delivery of RFID system).

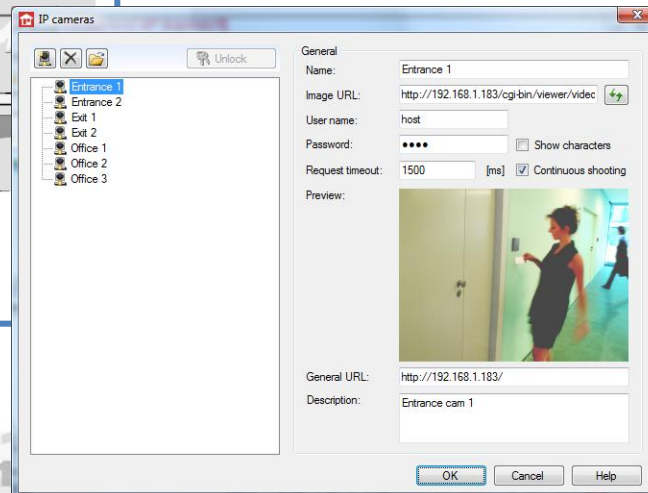
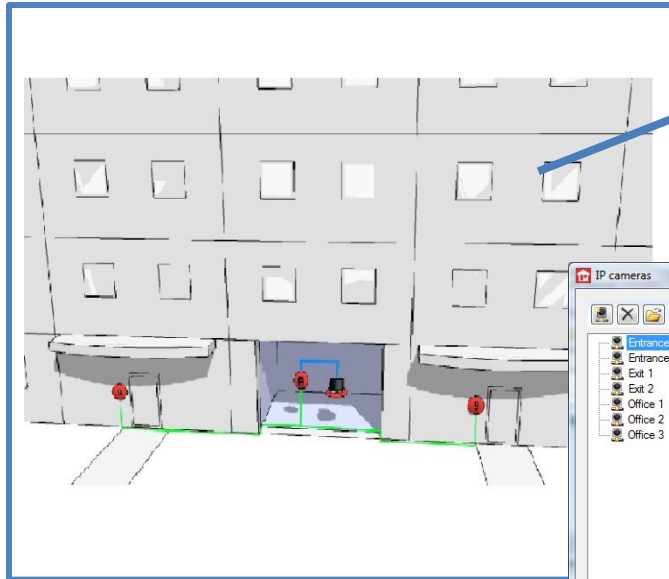

Slim VoIP/SIP Door Phone

RFID – events archive

Store all important data on all events of RFID enabled VoIP video doorphones including images (snapshots) from a camera of the doorphone and external cameras

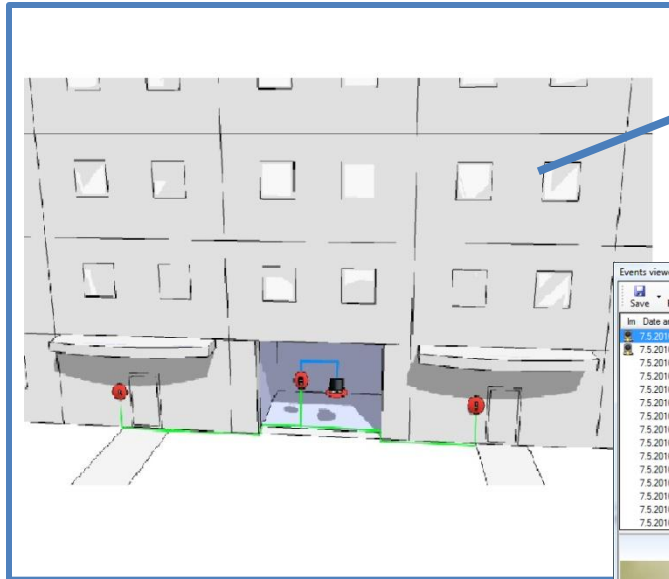

Events viewer

In	Date and time	Area	Module	Event	User	Access card	Key code
	7.5.2010 9:14:24	Area 1	02 - New module	Unknown ID	-	[000000014B65...	255
	7.5.2010 9:14:20	Area 1	02 - New module	Remote configura...	-	-	0
	7.5.2010 9:14:20	Area 1	04 - New module	Remote configura...	-	-	0
	7.5.2010 9:14:20	Area 1	03 - New module	Remote configura...	-	-	0
	7.5.2010 9:14:20	Area 1	01 - New module	Remote configura...	-	-	0
	7.5.2010 9:14:18	Area 1	02 - New module	Strike closed	-	-	0
	7.5.2010 9:14:11	Area 1	02 - New module	Strike released	-	-	0
	7.5.2010 9:14:11	Area 1	02 - New module	Remote door ope...	-	-	0
	7.5.2010 9:14:08	Area 1	03 - New module	Remote door ope...	-	-	0
	7.5.2010 9:14:04	Area 1	01 - New module	Strike closed	-	-	0
	7.5.2010 9:14:02	Area 1	04 - New module	Remote door ope...	-	-	0
	7.5.2010 9:13:57	Area 1	01 - New module	Strike released	-	-	0
	7.5.2010 9:13:57	Area 1	01 - New module	Remote door ope...	-	-	0
	7.5.2010 9:13:53	Area 1	04 - New module	Remote configura...	-	-	0

Entrance_1 7.5.2010 9:14:31

Entrance_2 7.5.2010 9:14:31



GDI - GSM Door Intercom

1 or 2 push buttons , vandal resistant version available



In the memory of each button there can be stored up to seven phone numbers in the sequence. After pressing a button, GDI dials the first phone number.

If within a certain time there is no answer, i.e.

- the call is rejected
- the subscriber is unavailable
- the subscriber does not answer then the GDI dials the next phone number in the stored sequence.

1001010111011101100010110101011010
0010111010100011011010100110100110110
11001010111001010100110101011110010100001101011

GDI - GSM Door Intercom

Incoming calls can be:

- all rejected
- all automatically received
- only calls from the list of phone numbers stored in the memory of GDI can be received automatically



GDI - GSM Door Intercom

2 relays, 4 modes

Gates, doors can be opened (close output relay) by:

- an unanswered call from predefined phone numbers (free of charge ring)
- sending a defined DTMF code (by pressing a defined button on the phone's keypad) during a call
- SMS text from defined phone numbers



GDI can send SMS text with the telephone number from which the opening was activated and the date and time of opening.



GDI - GSM Door Intercom

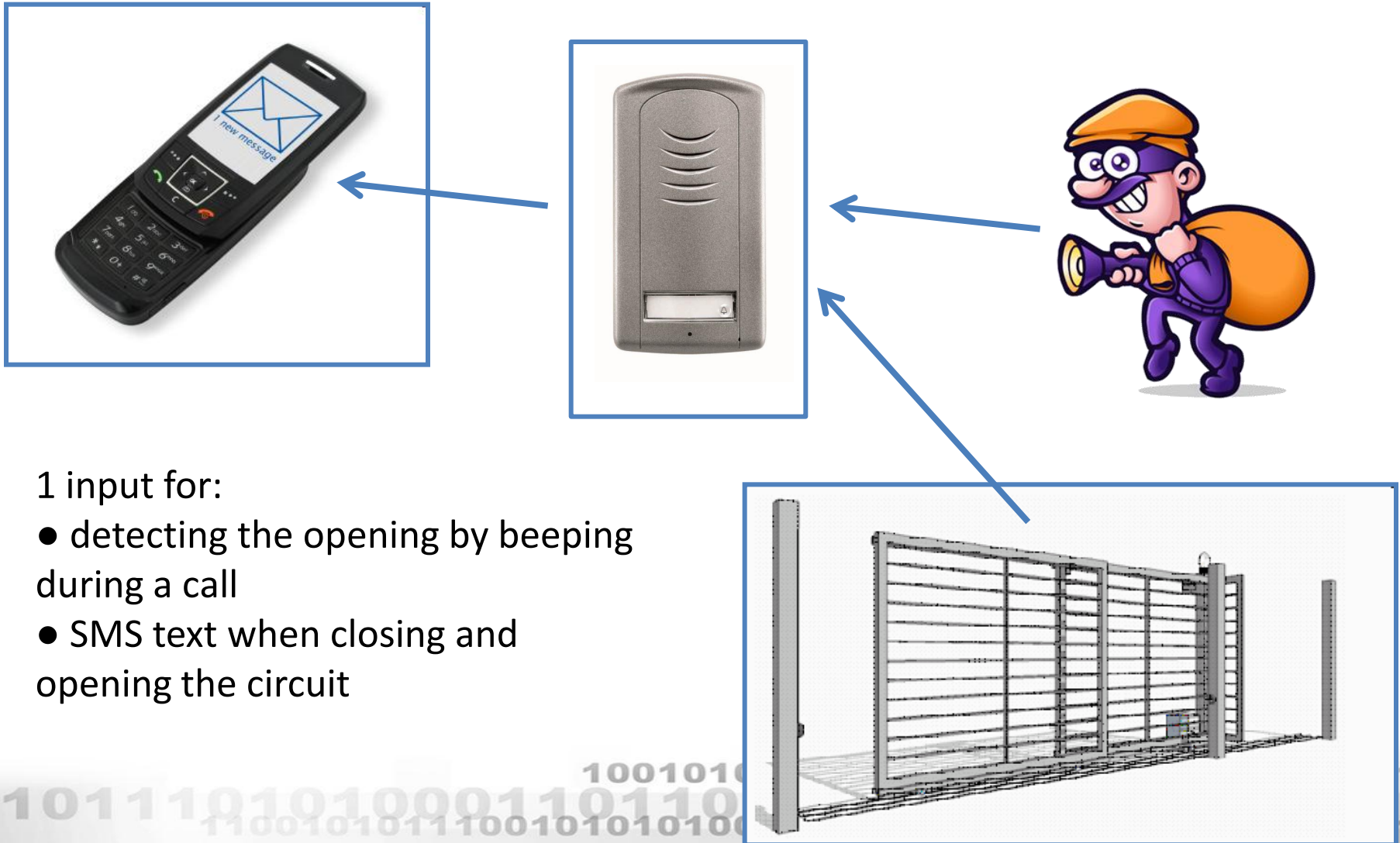

1 input for:

- detecting the opening by beeping during a call
- SMS text when closing and opening the circuit



GDI - GSM Door Intercom



All the important states and actions, i.e.

- standby
 - dialing
 - incorrect PIN
 - not logged into the network
 - error
 - open (relay on)
- etc.

are commented by voice messages.



GDI - GSM Door Intercom

backup battery

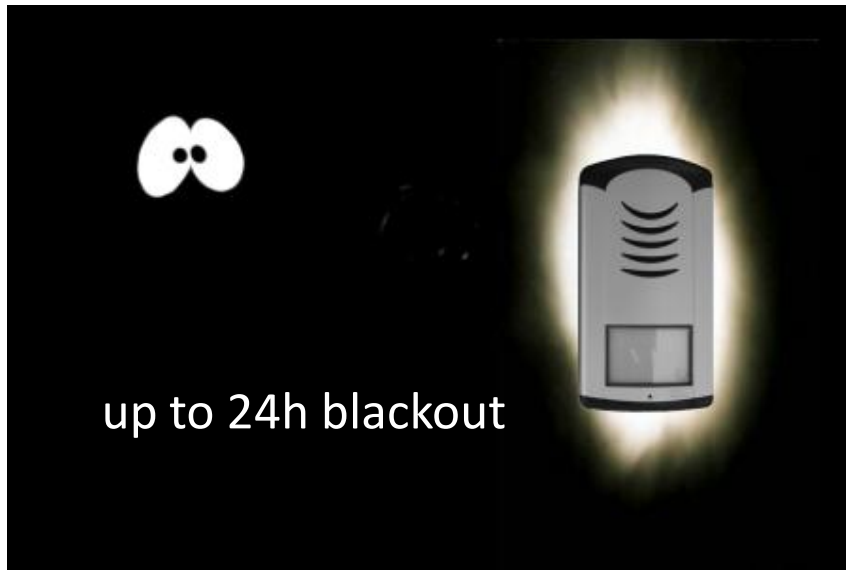

Power supply by solar batteries



GDI - GSM Door Intercom

3 possibilities (ways) of parameter setting

Direct programming of the GDI's SIM card in a standard mobile phone.

Via the program from the PC.

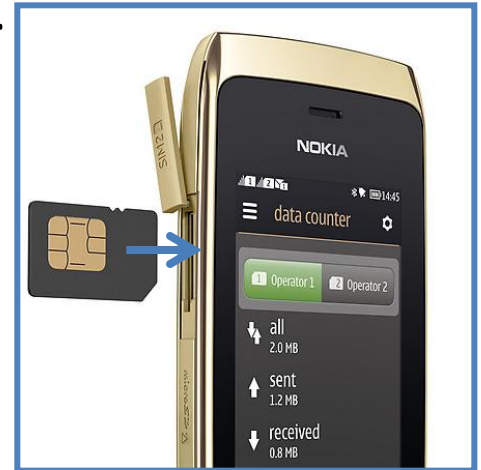
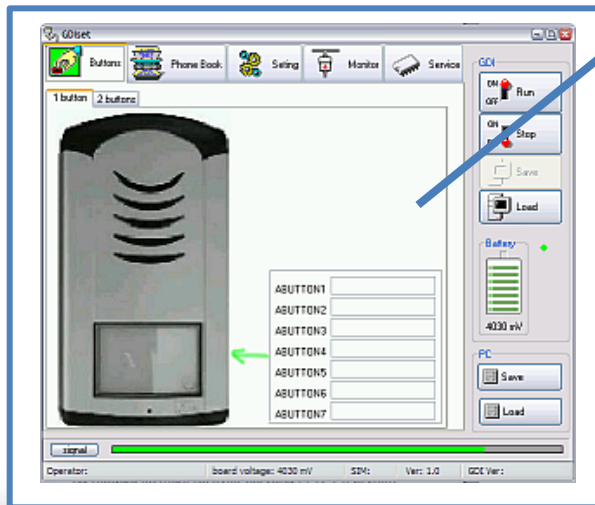

Using the setting text SMS messages from defined phone numbers.



Analog Brave Slim Door Phone



- 1 or 2 push buttons , vandal resistant version available
- with or without analog camera

In the memory of each button there can be stored 2 phone numbers.

- Telephone number for the day / telephone number for the night (mode can be switched manually or automatically according to the time server on the Internet).

- By pressing the same button once again, the second number in the sequence is dialed.

- The second number is also automatically dialed if the called party is busy or does not respond.



Analog Brave Slim Door Phone

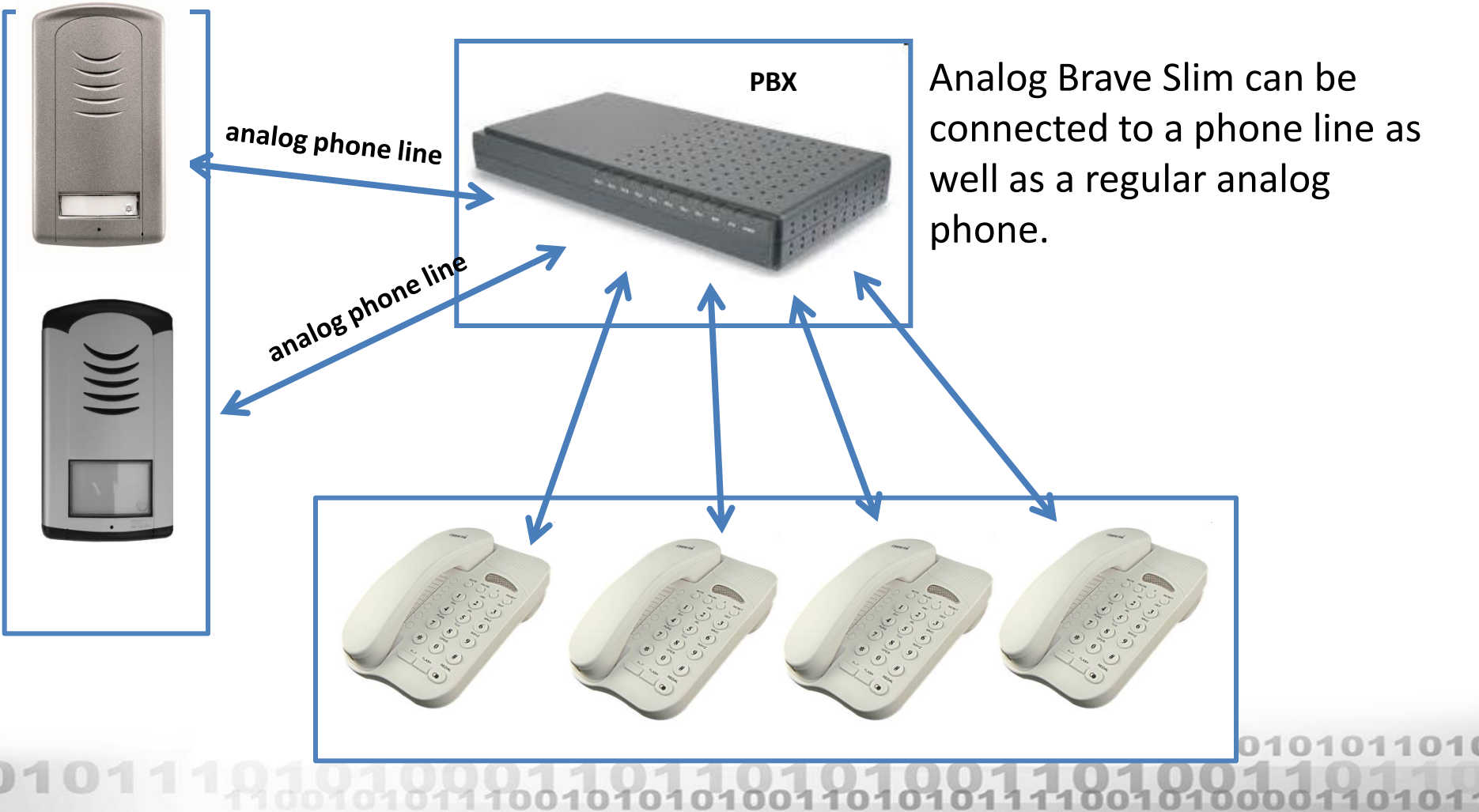

Analog Brave Slim Door Phone



PAL video 1V / 75ohm



Analog camera with continuous or automatic operation - camera is only active when the Brave Slim is activated.



Analog Brave Slim Door Phone

2 relays / 8 modes for gates, doors etc.

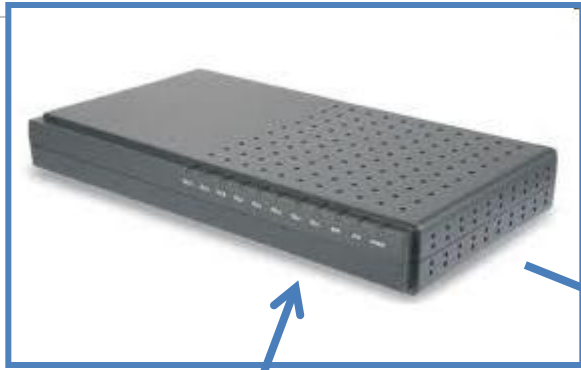

Controlling relay during a call via DTMF

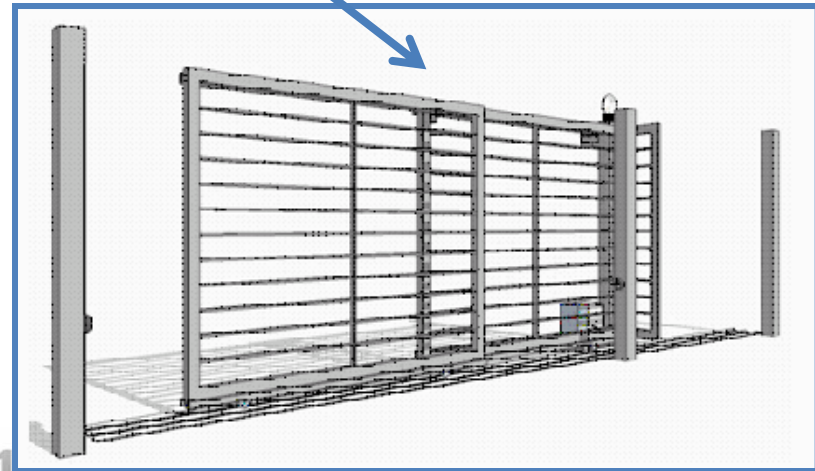
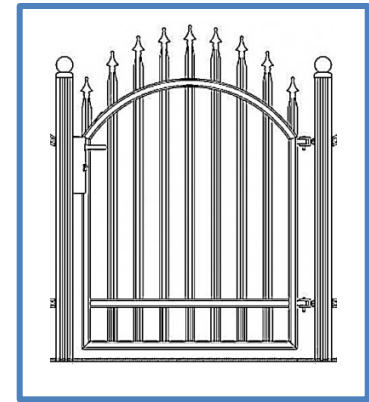

Function COSW-CodeSwitch for the first relay. When using this function it is not possible to release the relay simply by connecting or disconnecting the power supply of the lock, the lock is still activated. Activation is performed only when the compliant serial information is transmitted between the Brave Slim and the plate COSW-CodeSwitch.



Analog Brave Slim Door Phone

Analog Brave Slim behaves as a regular analog phone – it is powered from the telephone line and does not require external power.

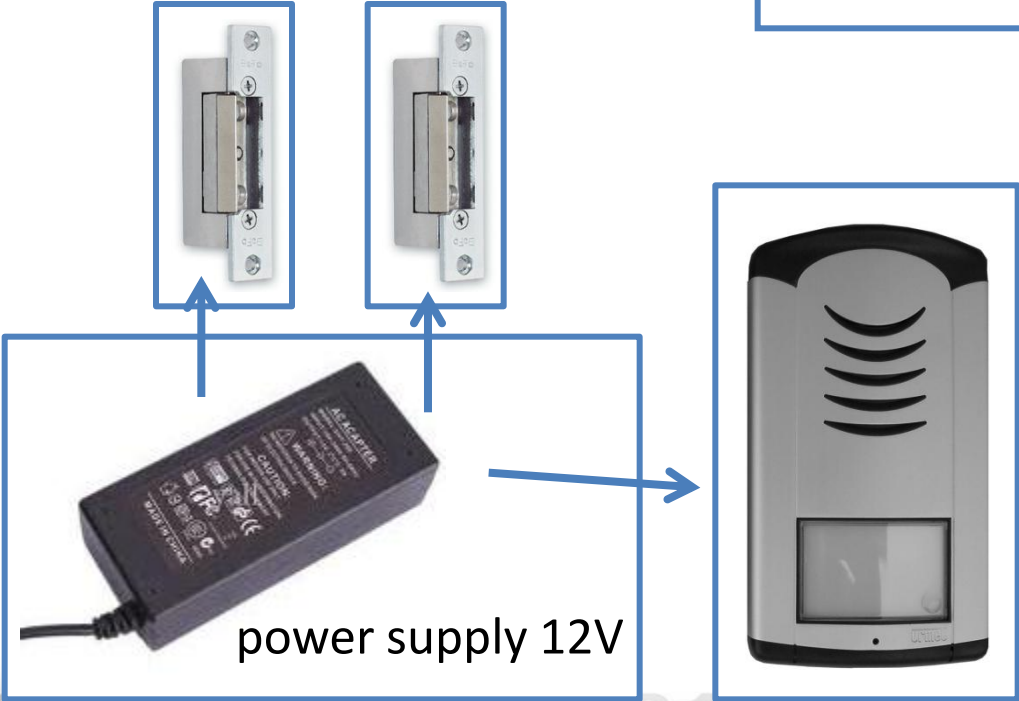
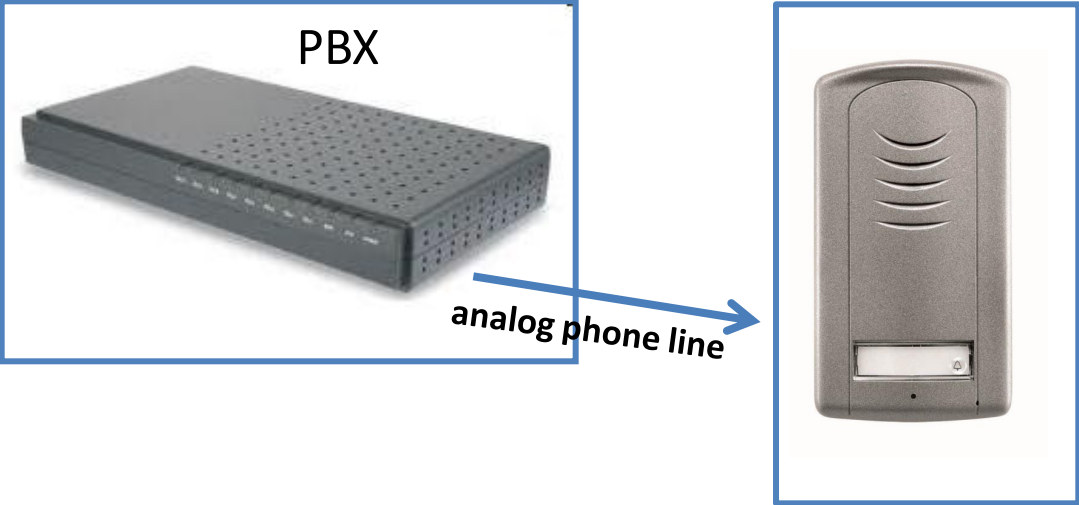

When using electric locks, the Brave Slim requires an external power supply. In this case the Brave Slim is powered from this source - it does not need permanent voltage on the telephone line.



Analog Brave Slim Door Phone

All parameters of the Brave Slim can be configured:



USB cable

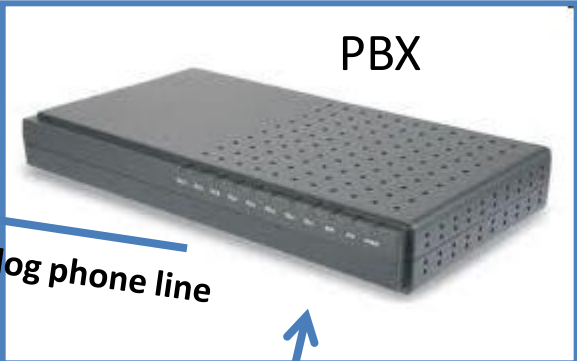

PBX

analog phone line



By program from PC

During a call via DTMF



IPDP - VoIP/SIP Door Phone

Modular system allows to connect:

- 1 to 64 buttons
- a numerical keyboard + 4 – 18 standard buttons
- IP camera

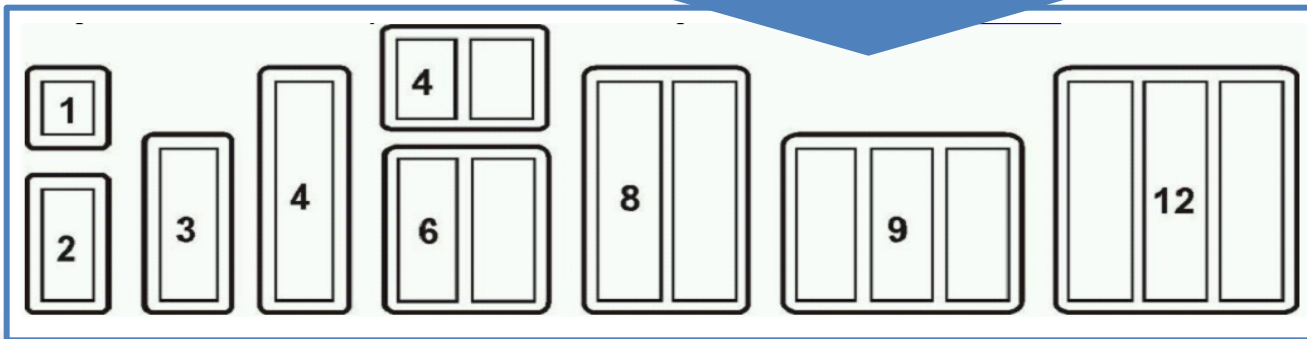
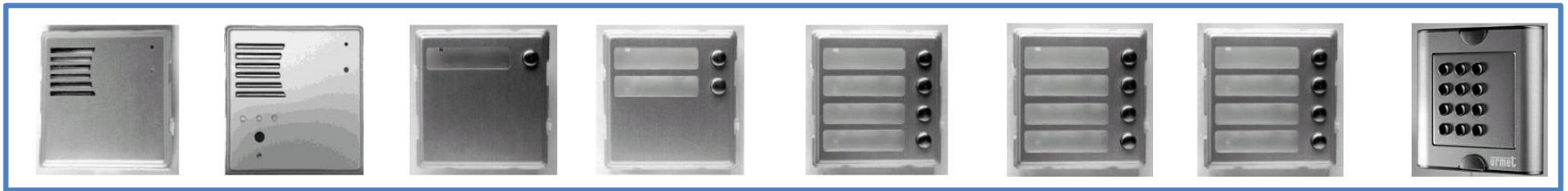

Examples of frames for installing the modules



IPDP - VoIP/SIP Door Phone



Keyboard mode:

- dial phone numbers as on a telephone keypad
- dial memory number 01-64 with a saved phone number
- dialing code for an access code lock

Inside the memory of each button there can be stored 2 phone numbers (IP addresses).

- Telephone number for the day / telephone number for the night (the mode can be switched manually or automatically according to the time server on the Internet).
- Again by pressing the same button, the second number is dialled in the sequence.

IPDP - VoIP/SIP Door Phone

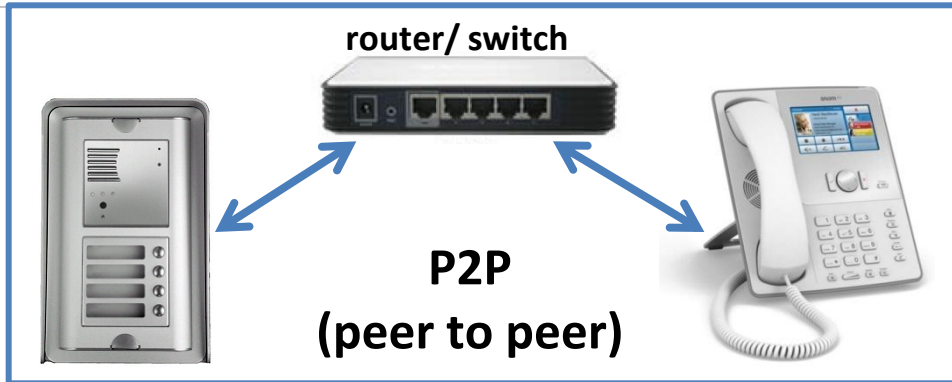

IP DP allows connection to the Ethernet via P2P (peer to peer) protocol and also via SIP proxy.

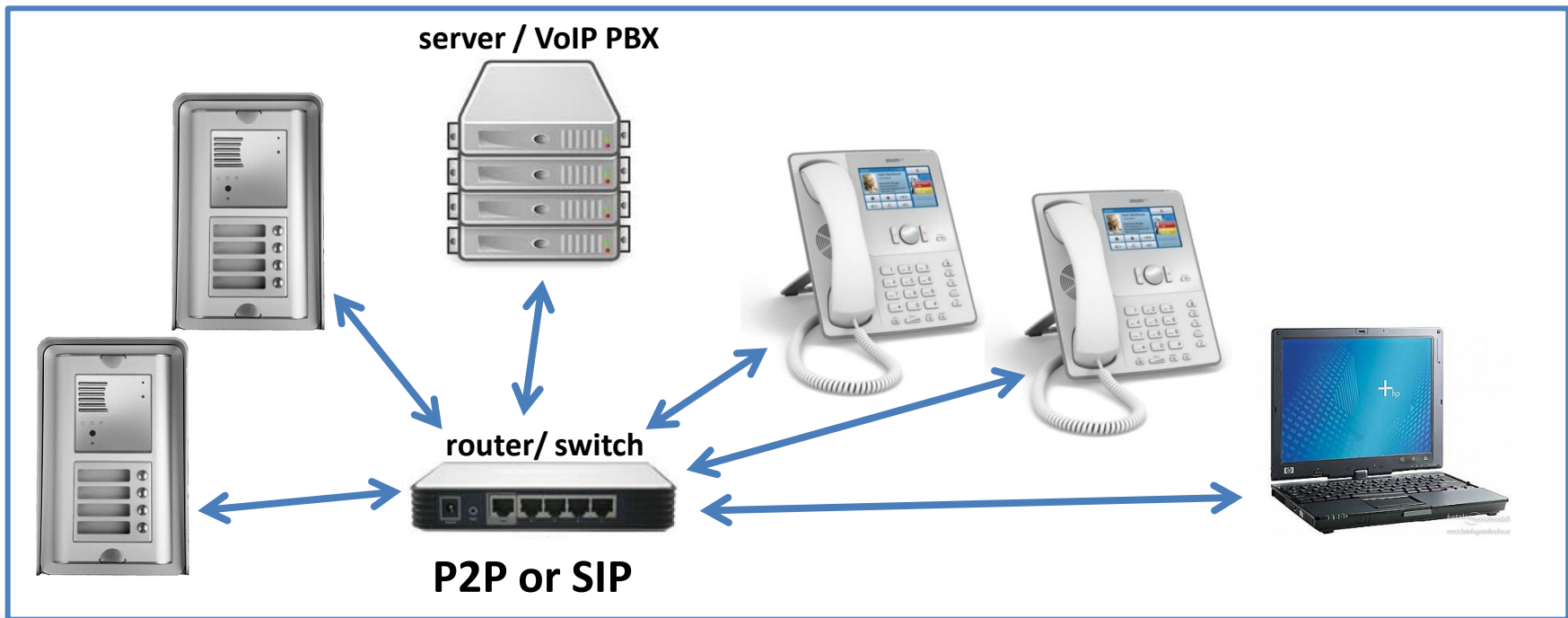

IPDP - VoIP/SIP Door Phone

IP DP enables, in addition to the normal VoIP phone talk, watching the video stream of a colour, built-in camera and operate opening locks (relays) via applications for

- Windows PC
- iPhone/iPad
- Android

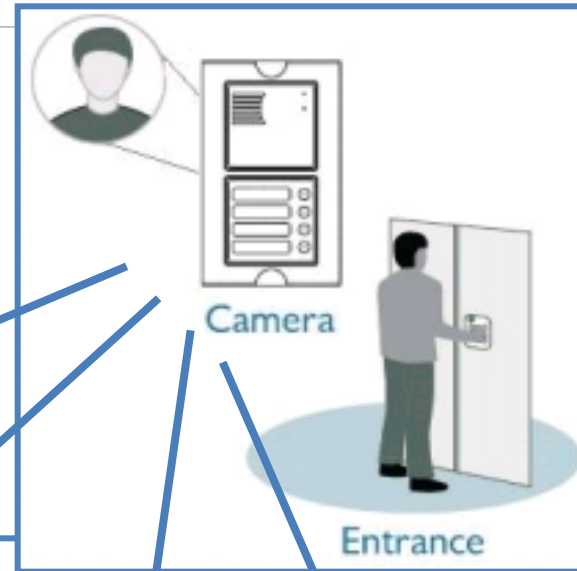

IPDP - VoIP/SIP Door Phone

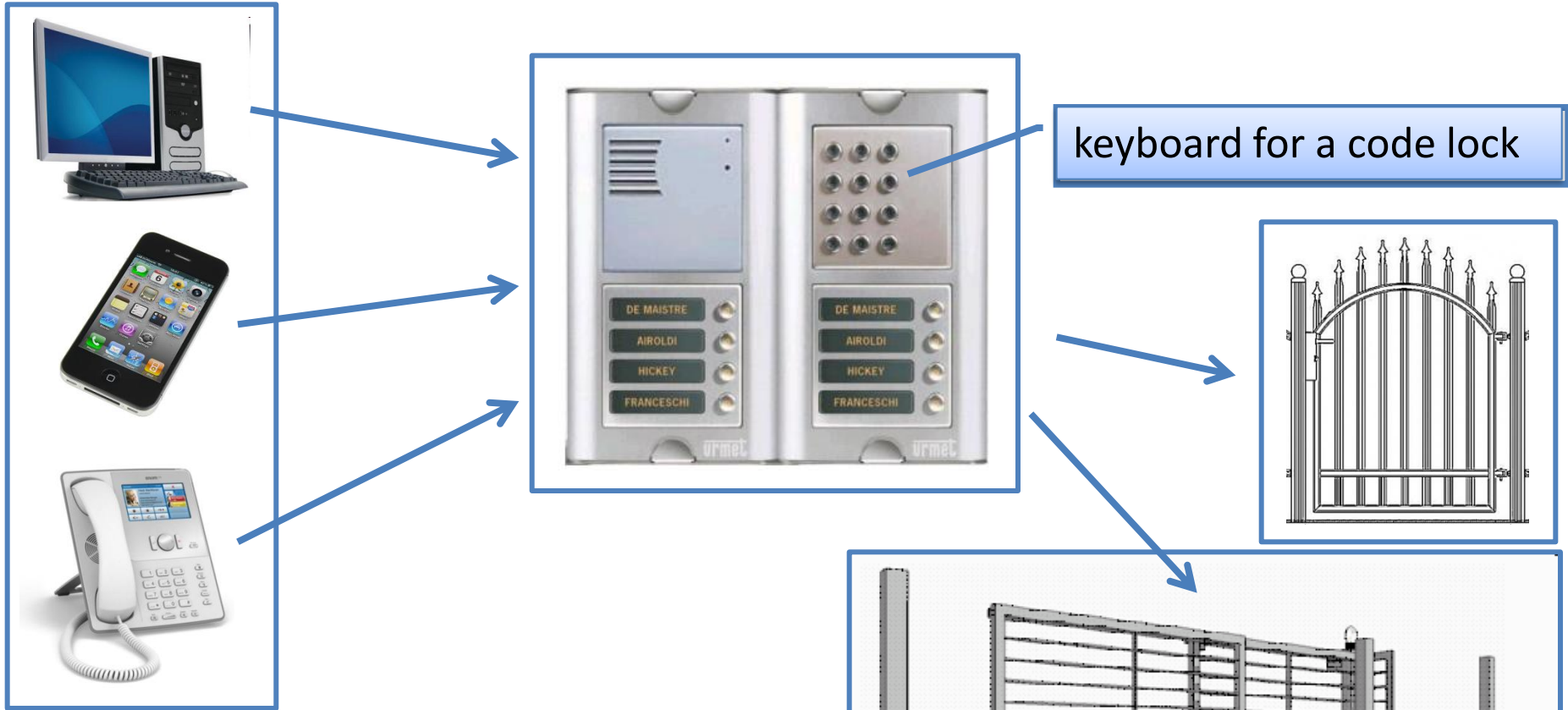

- 2 relays / 5 modes for gates, doors etc.



IPDP - VoIP/SIP Door Phone

IP DP can be powered directly via Ethernet (PoE).

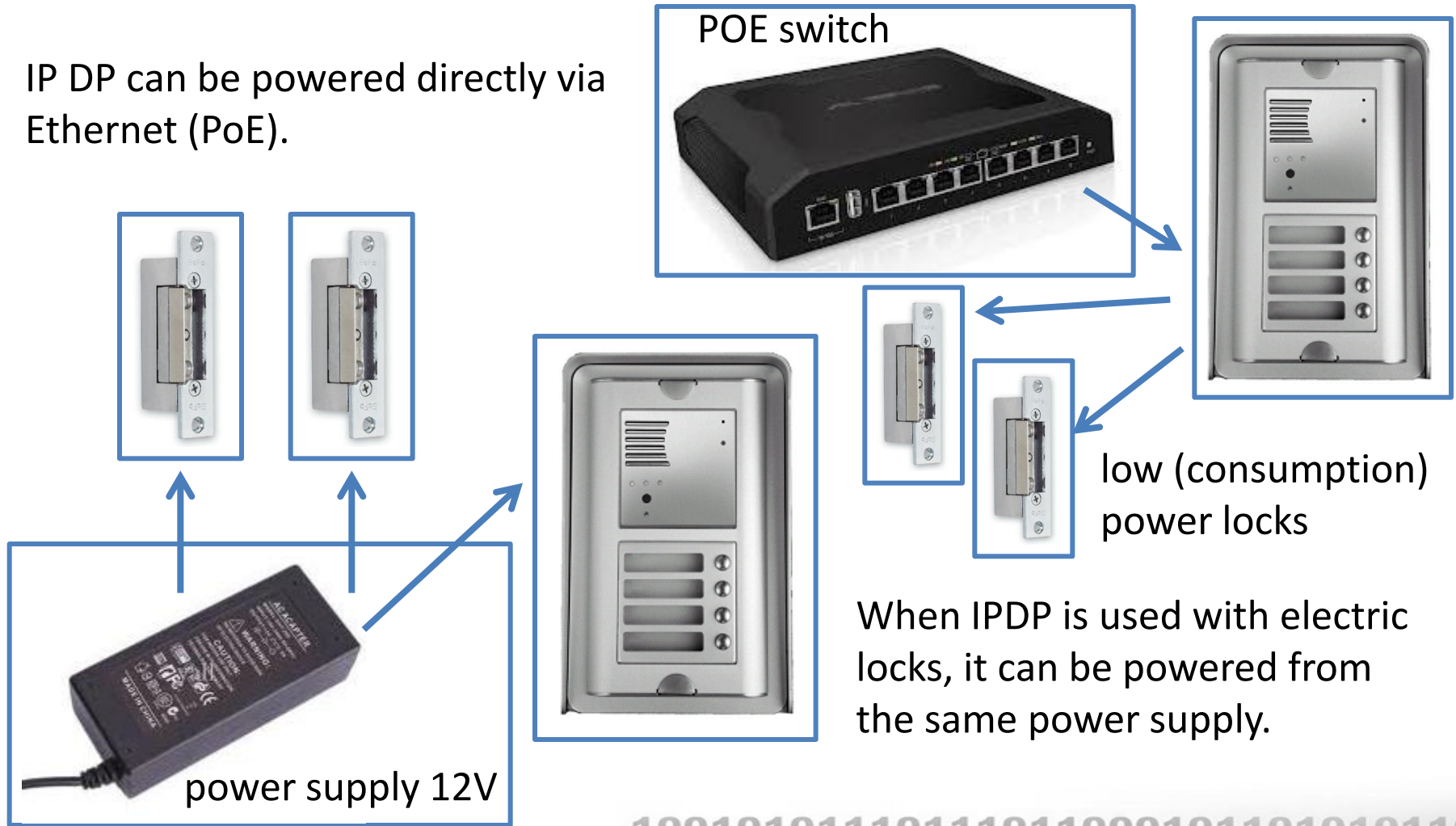

IPDP - VoIP/SIP Door Phone

Setting of all parameters can be done remotely via a http web interface (any web client) after login via name and password.

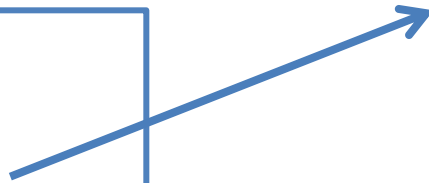

Brave Steel Analog Door Phone



Modular system allows to connect:

- 1 to 64 buttons
- a numerical keyboard including 4 – 18 standard buttons
- analog or IP camera
- RFID

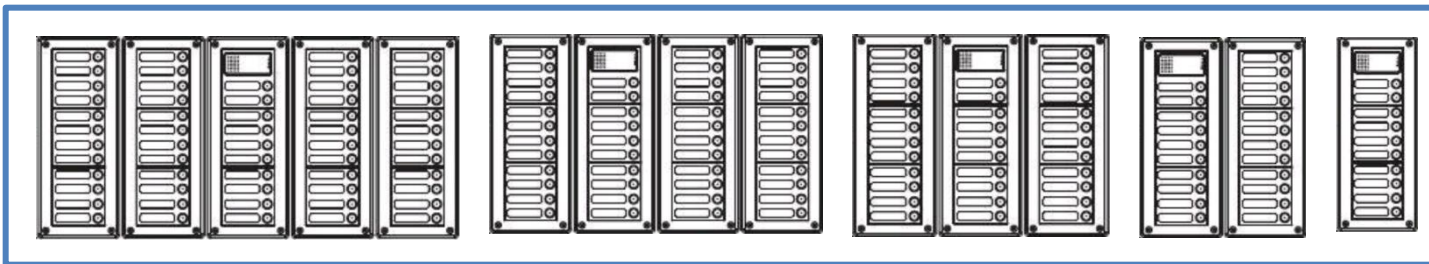
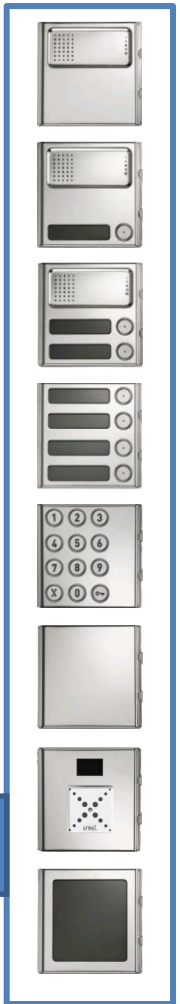

Examples of frames for installing the modules



Brave Steel Analog Door Phone

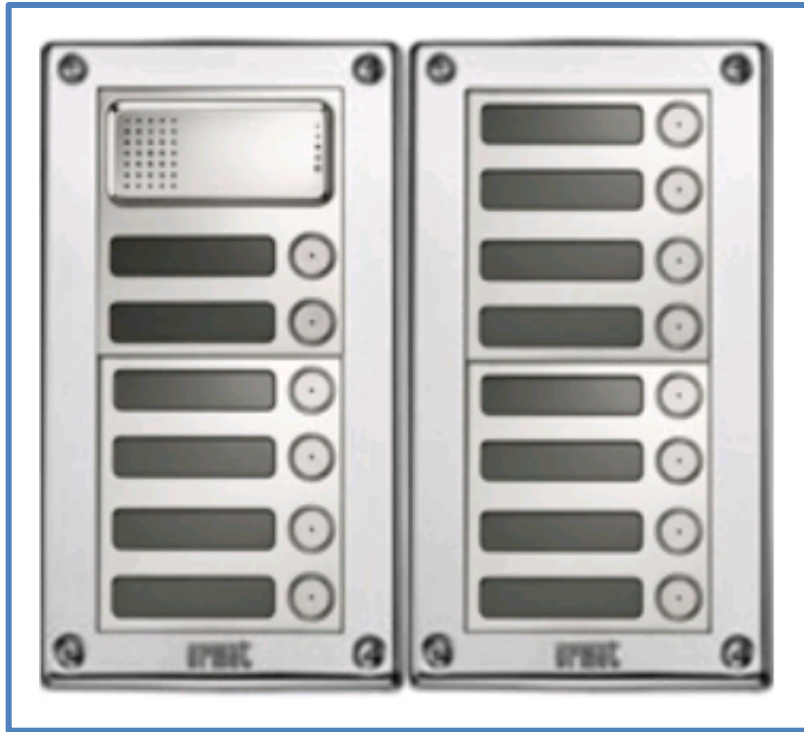

Keyboard mode enables:

- dialling phone numbers as on the telephone keypad
- dialling a memory number 01-64 with a stored phone number
- dialling an access code for the code lock

In the memory of each button there can be stored 2 phone numbers.

- Telephone number for the day / telephone number for the night (mode can be switched manually or automatically).
- By pressing the same button once again, the second number in the sequence is dialled.
- The second number is also automatically dialled if the called party is busy or does not respond.



Brave Steel Analog Door Phone

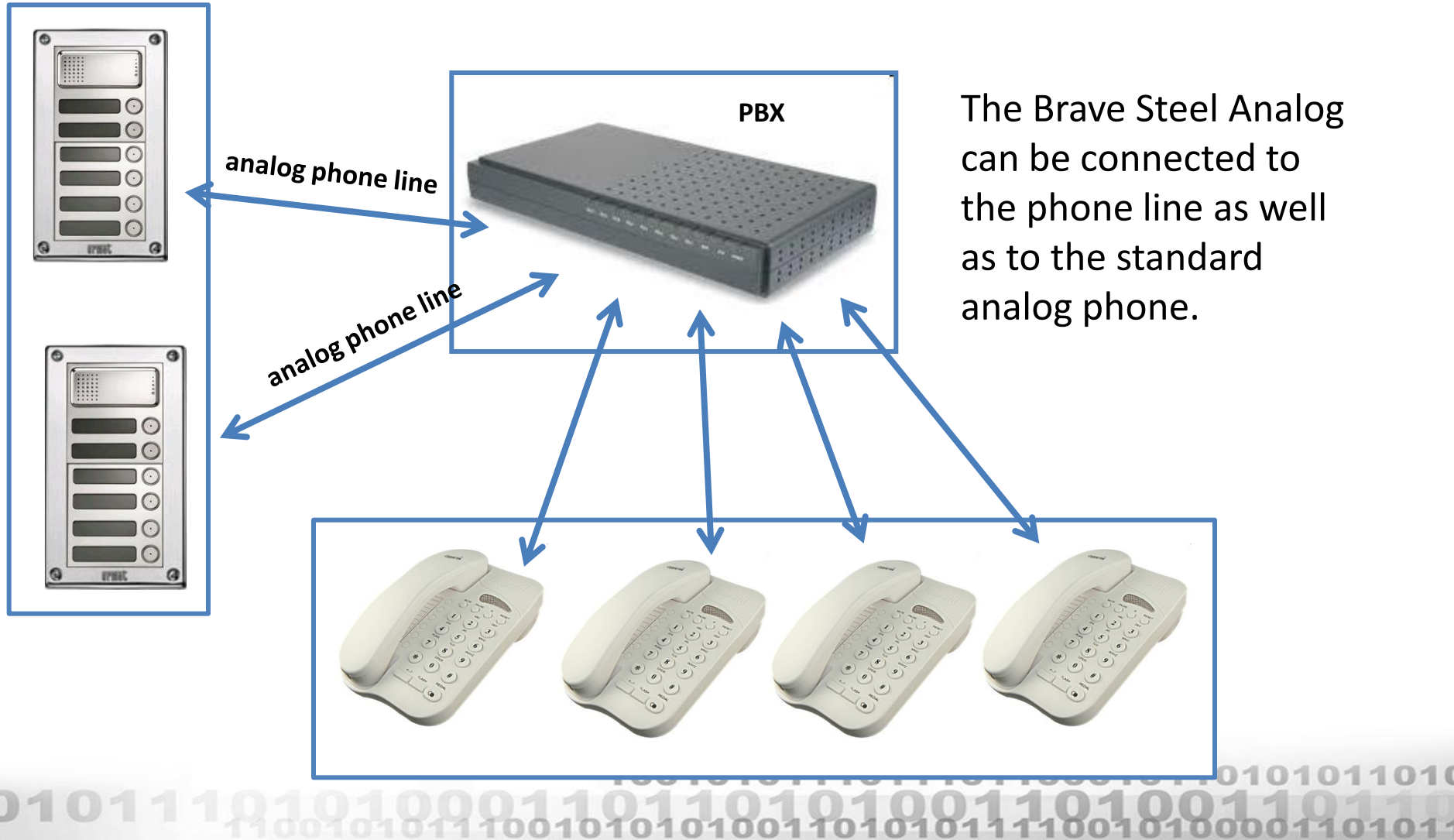

Brave Steel Analog Door Phone



PAL video 1V / 75ohm



Analog camera with continuous or automatic operation - camera is only active when the Brave Steel Analog is activated.



Brave Steel Analog Door Phone

2 relays / 8 modes for gates, doors etc.

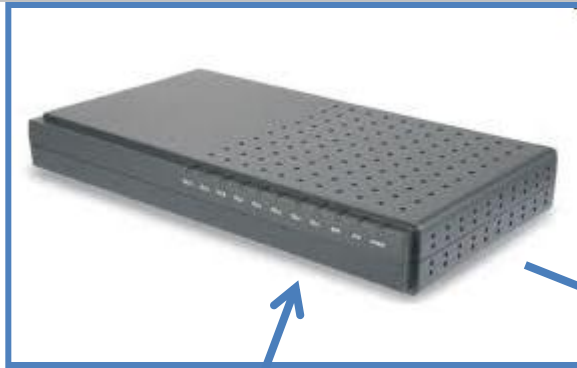

Controlling relay during a call via DTMF



keyboard for code lock

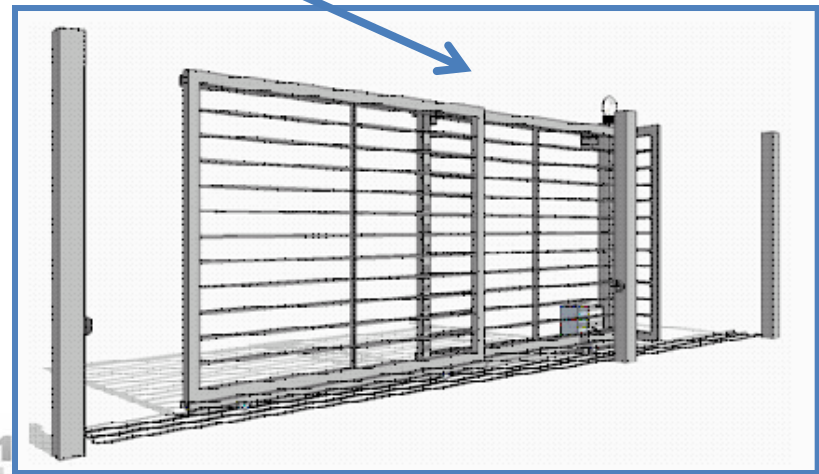
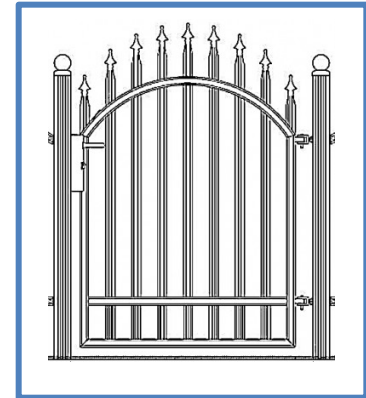

Function COSW-CodeSwitch for the first relay. When using this function it is not possible just by connecting or disconnecting the supply activate the lock. Activation is performed only when there is a compliance of serial information transmitted between the Brave Steel Analog and the plate CodeRelay.

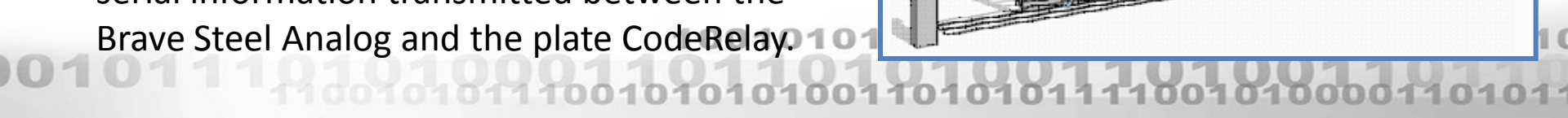

Brave Steel Analog Door Phone

The Brave Steel Analog behaves as a regular analog phone – it is powered from the telephone line and does not require external power.

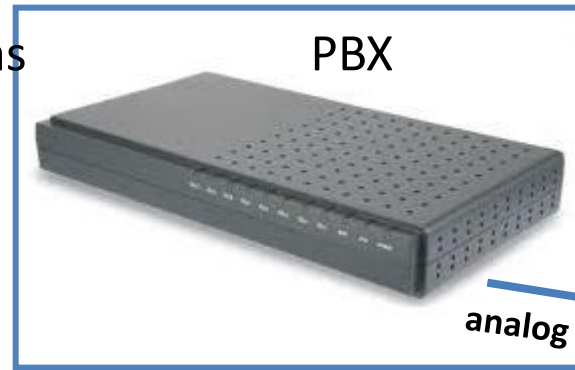

analog phone line



When using electric locks, the Brave Steel Analog requires an external power supply. In this case the Brave Steel Analog is powered from this source - it does not need permanent voltage on the telephone line.



Brave Steel Analog Door Phone

All parameters of the Brave Steel Analog can be configured:



USB cable



By program from PC

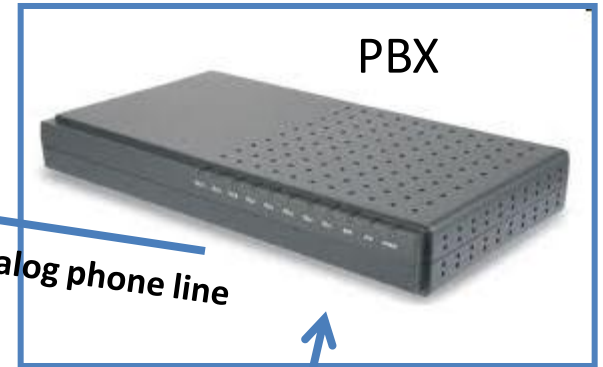

PBX

analog phone line



During a call via DTMF



IPDP Brave Steel - Modular VoIP Door Phone



Modular system allows to connect:

- 1 to 64 buttons
- a numerical dialling keyboard and 4 – 18 standard call buttons
- IP camera
- RFID

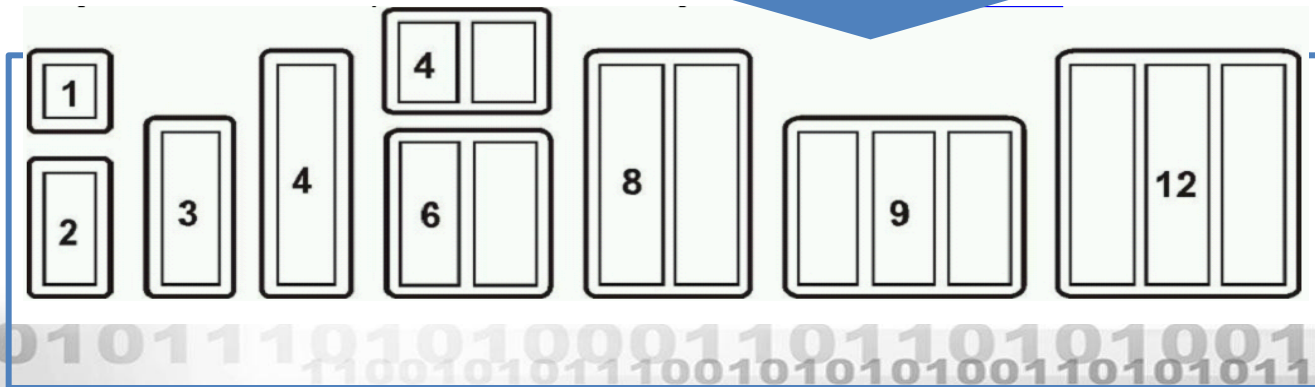

Examples of frames for installing the modules



IPDP Brave Steel - Modular VoIP Door Phone



Keyboard mode:

- dial phone numbers as on a telephone keypad
- dial memory number 01-64 with a saved phone number
- dialing code for an access code lock

Inside the memory of each button there can be stored 2 phone numbers (IP addresses).

- Telephone number for the day / telephone number for the night (the mode can be switched manually or automatically according to the time server on the Internet).
- Again by pressing the same button, the second number is dialed in the sequence.

100101111011101100010110101011010
1100101011100101010001101001101110

IPDP Brave Steel - Modular VoIP Door Phone

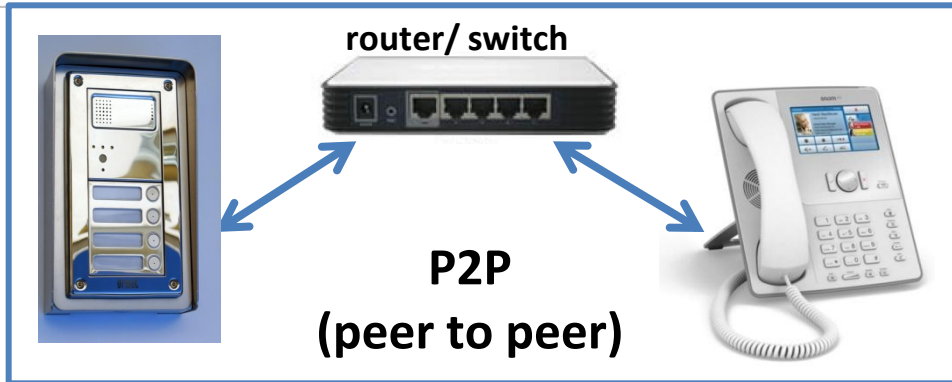

IP DP Brave Steel allows connection to the Ethernet via P2P (peer to peer) protocol and also via SIP proxy.

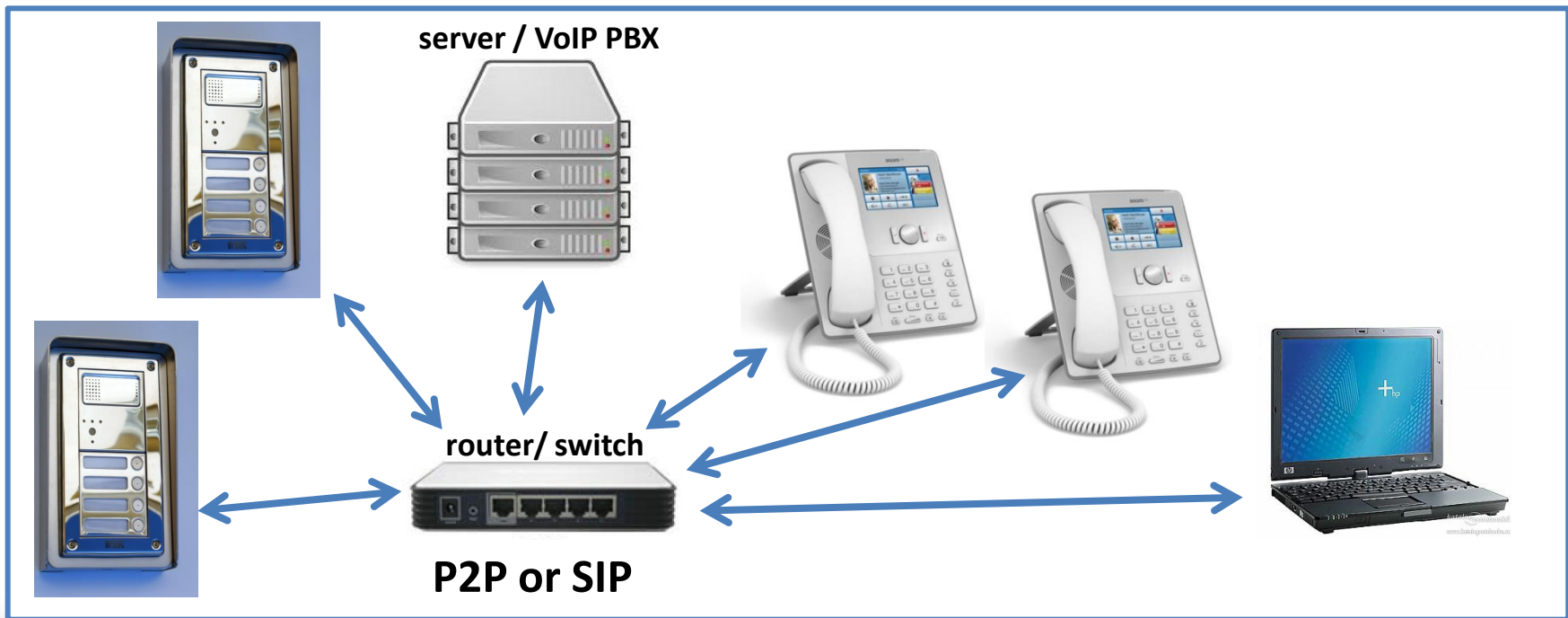

IPDP Brave Steel - Modular VoIP Door Phone

IP DP Brave Steel enables, in addition to the normal VoIP phone talk, watching the video stream of a colour, built-in camera and operate opening locks (relays) via applications for

- Windows PC
- iPhone/iPad
- Android

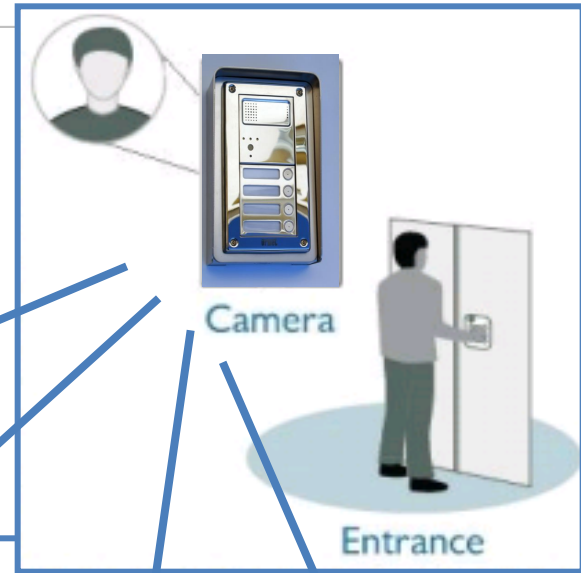

IPDP Brave Steel - Modular VoIP Door Phone



keyboard for a code lock

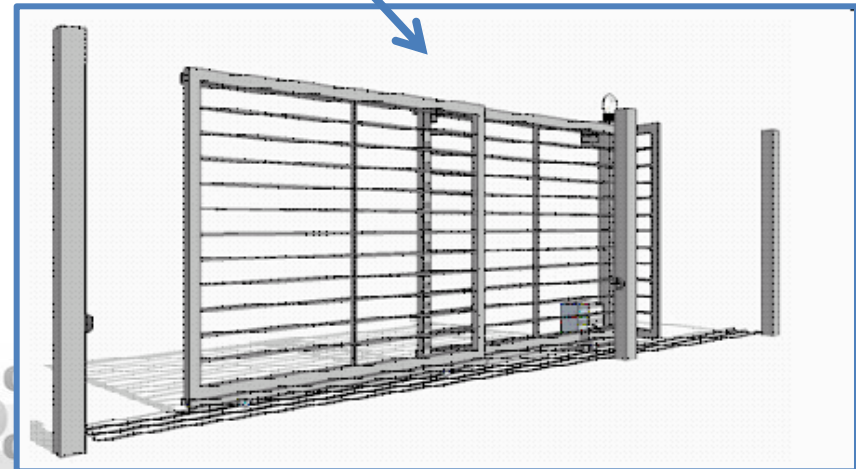
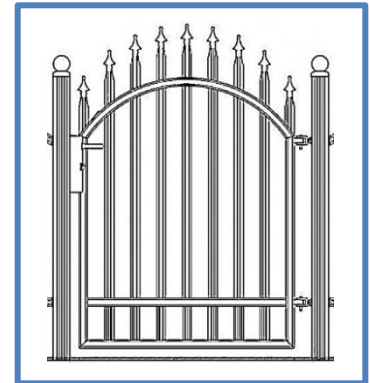

- 2 relays / 5 modes for gates, doors etc.



IPDP Brave Steel - Modular VoIP Door Phone

IP DP Brave Steel can be powered directly via Ethernet (PoE).

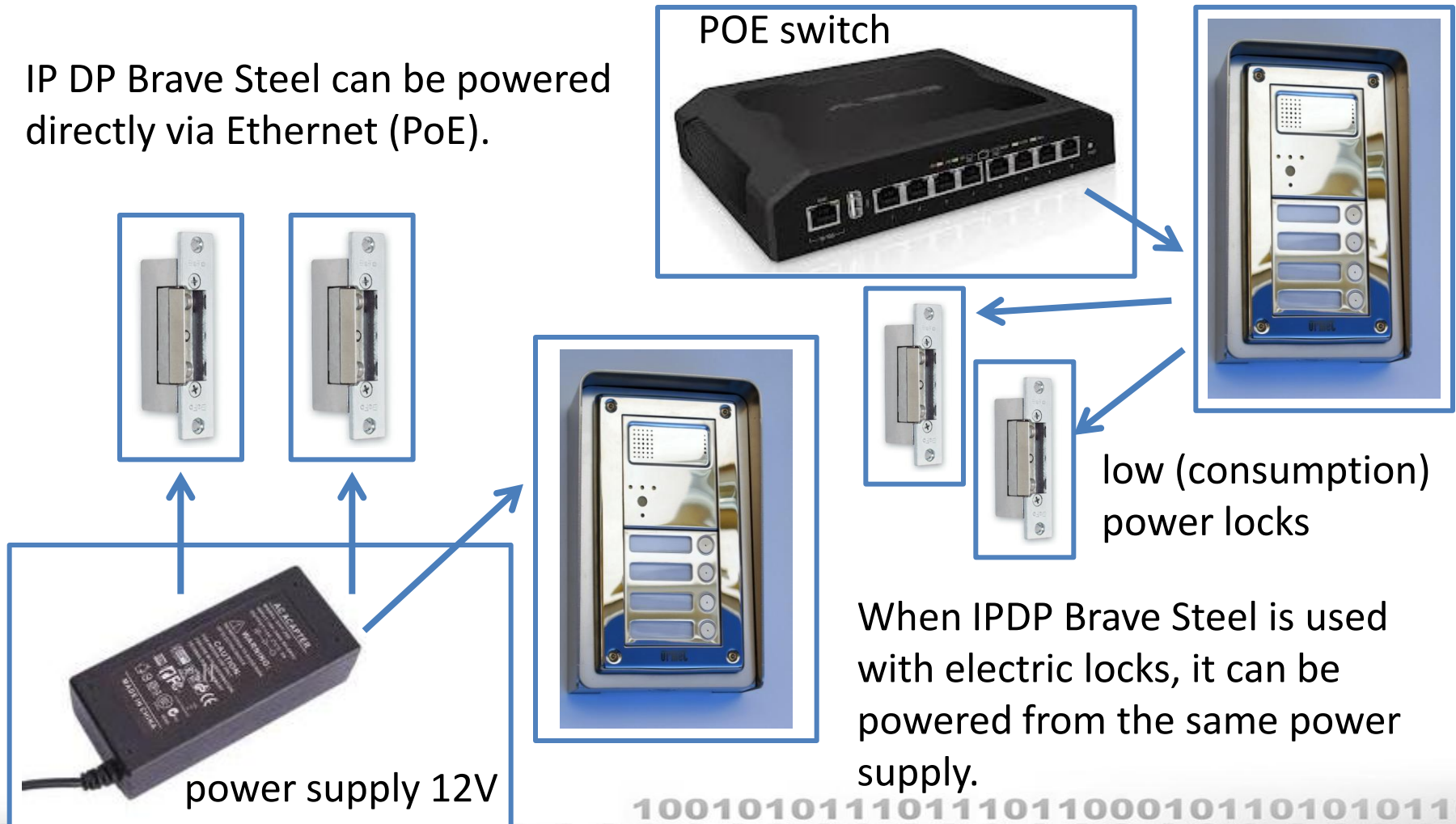

When IPDP Brave Steel is used with electric locks, it can be powered from the same power supply.



IPDP Brave Steel - Modular VoIP Door Phone

Setting of all parameters can be done remotely via a http web interface (any web client) after login via name and password.

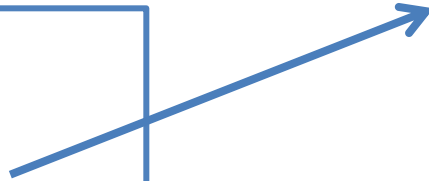

Alfacom BluePhone solution

BluePhone solution is iOS iPhone/iPad and Android compatible.

BluePhone consists of:

- BlueGate SIP1 SIP server/GSM router
- SIP based IPDP / IP Bell video doorphone
- WiFi PoE router

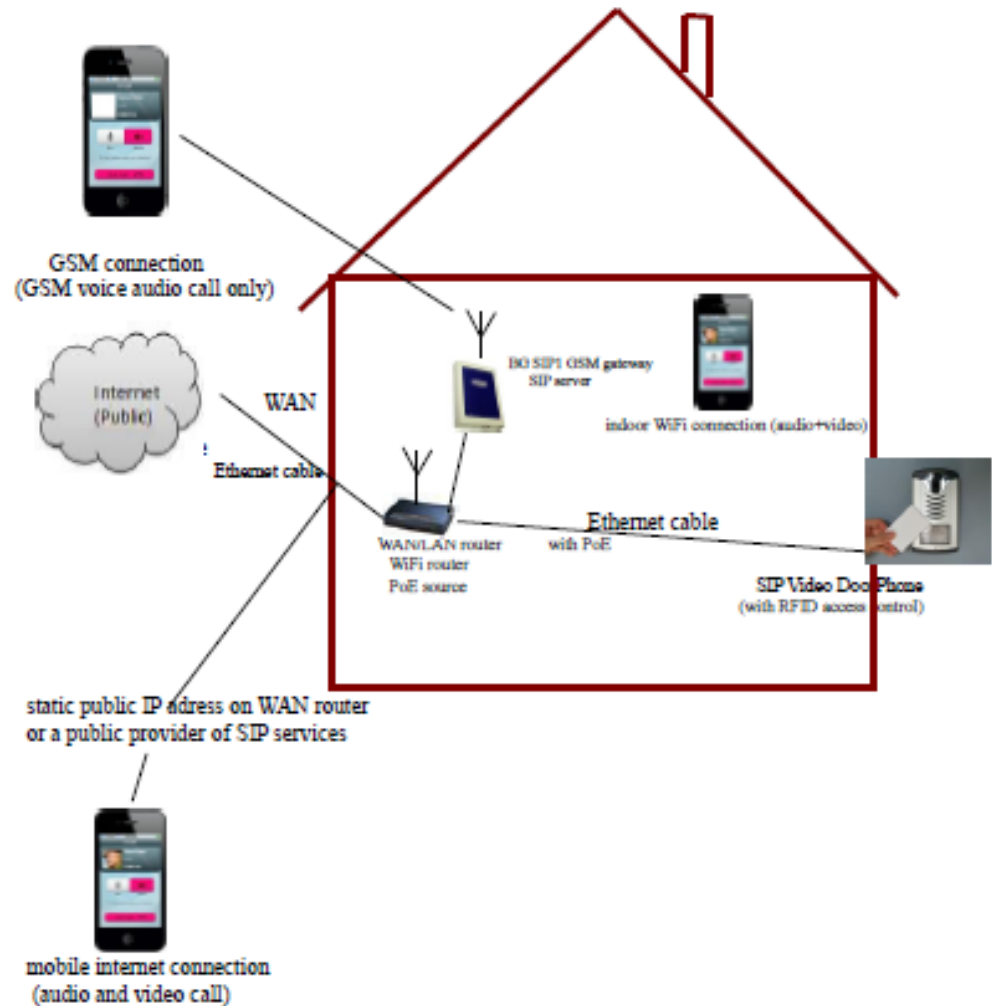

Alfacom IP video door entry security control system

- Panasonic IP Phone with special SW
- Alfacom SIP server
- Alfacom IP video doorphones

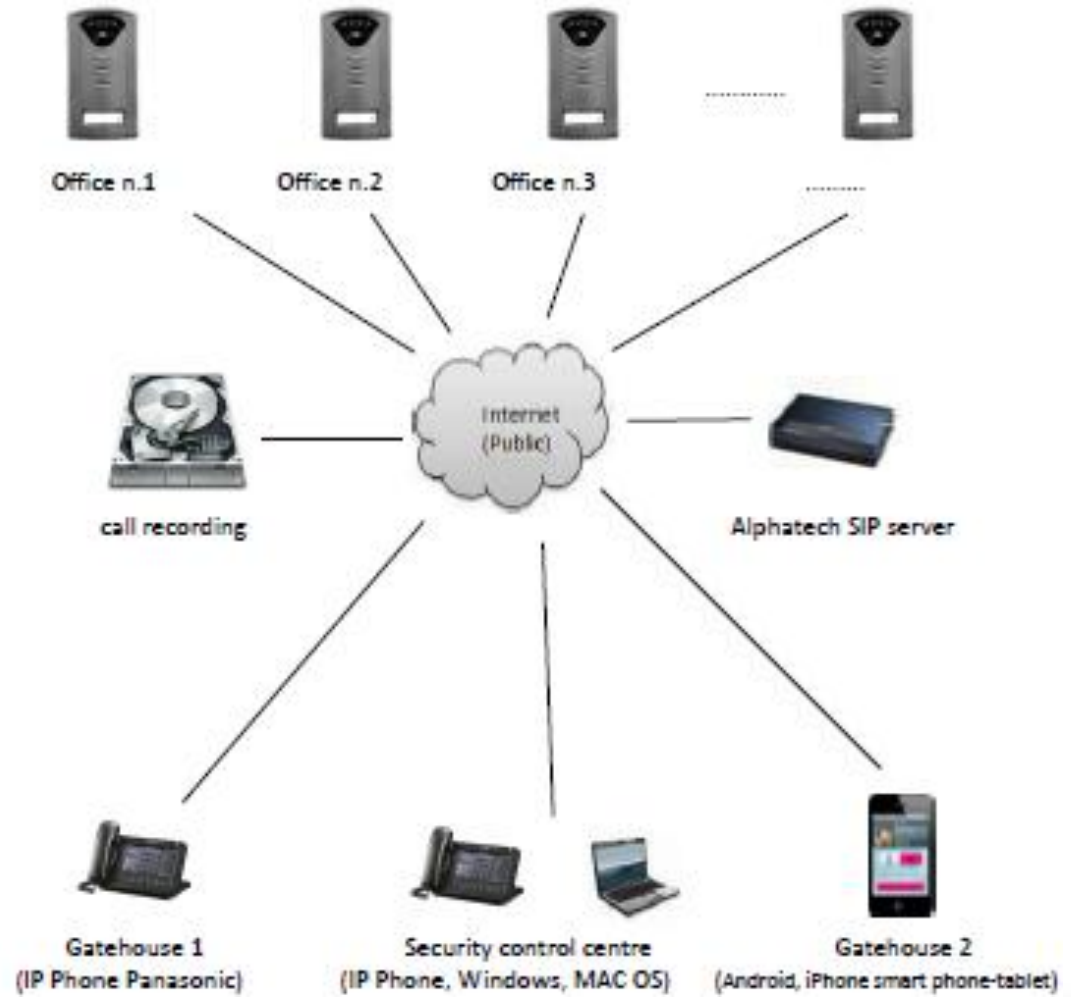

Alfacom IP video door entry security control system

- customized voice messages of the IP video doorphone during busy or inaccessible phone line – when a visitor presses a push button of the IP video doorphone and the line is occupied or inaccessible, the IP video doorphone will play pre-recorded, predefined voice messages to the visitor

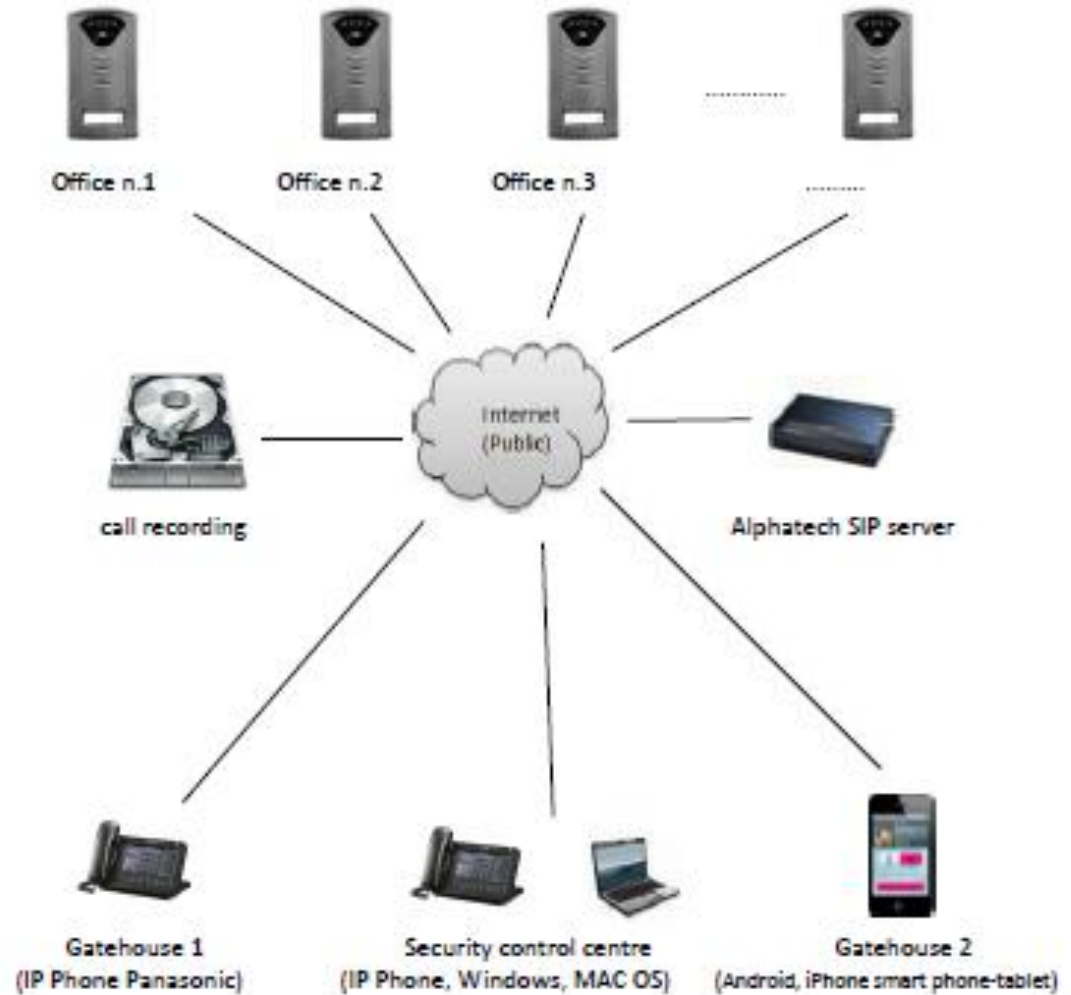

Alfacom IP video door entry security control system

- call transferring based on phone lines engagement – a call transfer plan can be created

e.g. when the phone line is busy, the IP video doorphone informs the visitor 3x times that the line is busy, then the IP video doorphone calls to a different phone line

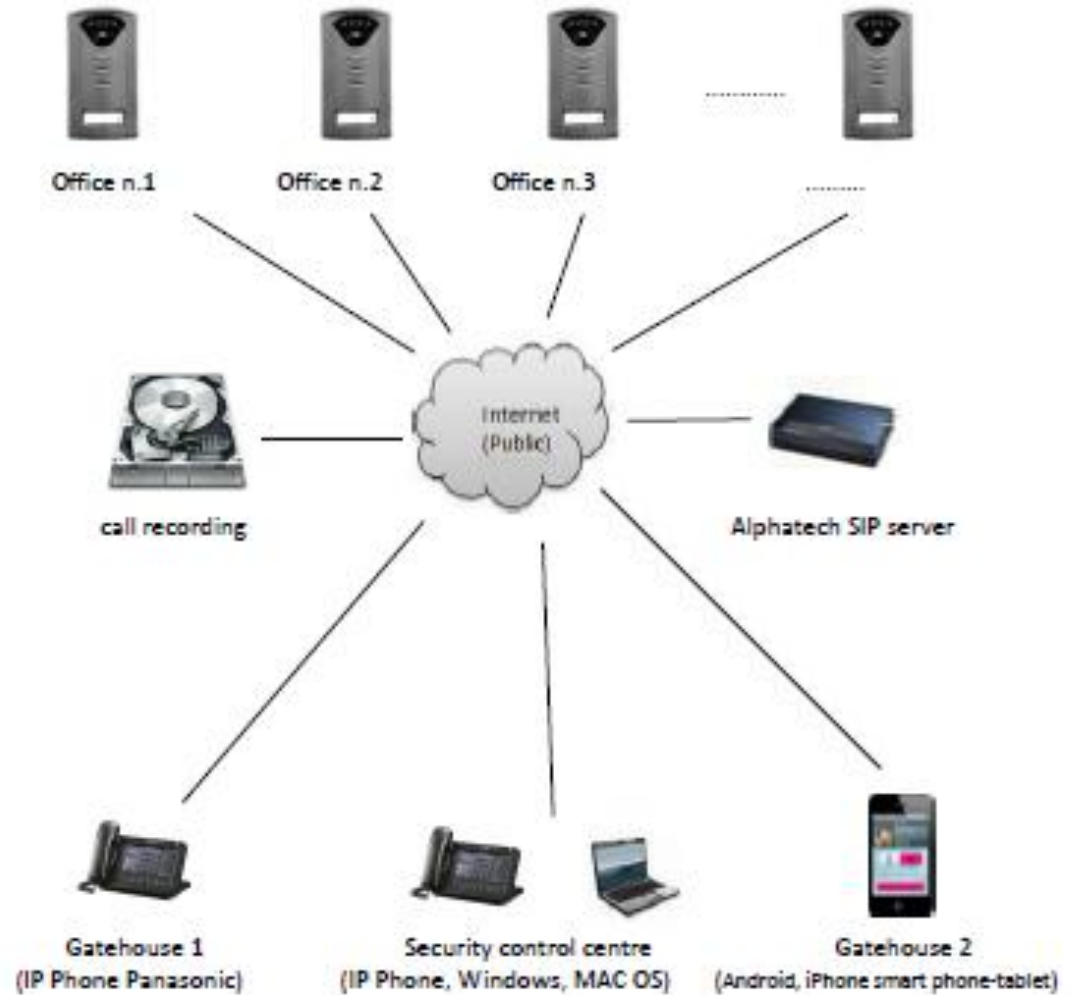

Alfacom IP video door entry security control system

- calls routing according to a real time schedule (month, day of week, exact hour of the day)
- voice mail box with advanced features when there is no answer, the IP video doorphone takes a picture of the visitor, records the voice message (voicemail box) and sends an email with the visitor's image and text message (time, date, place) to a designated email box.

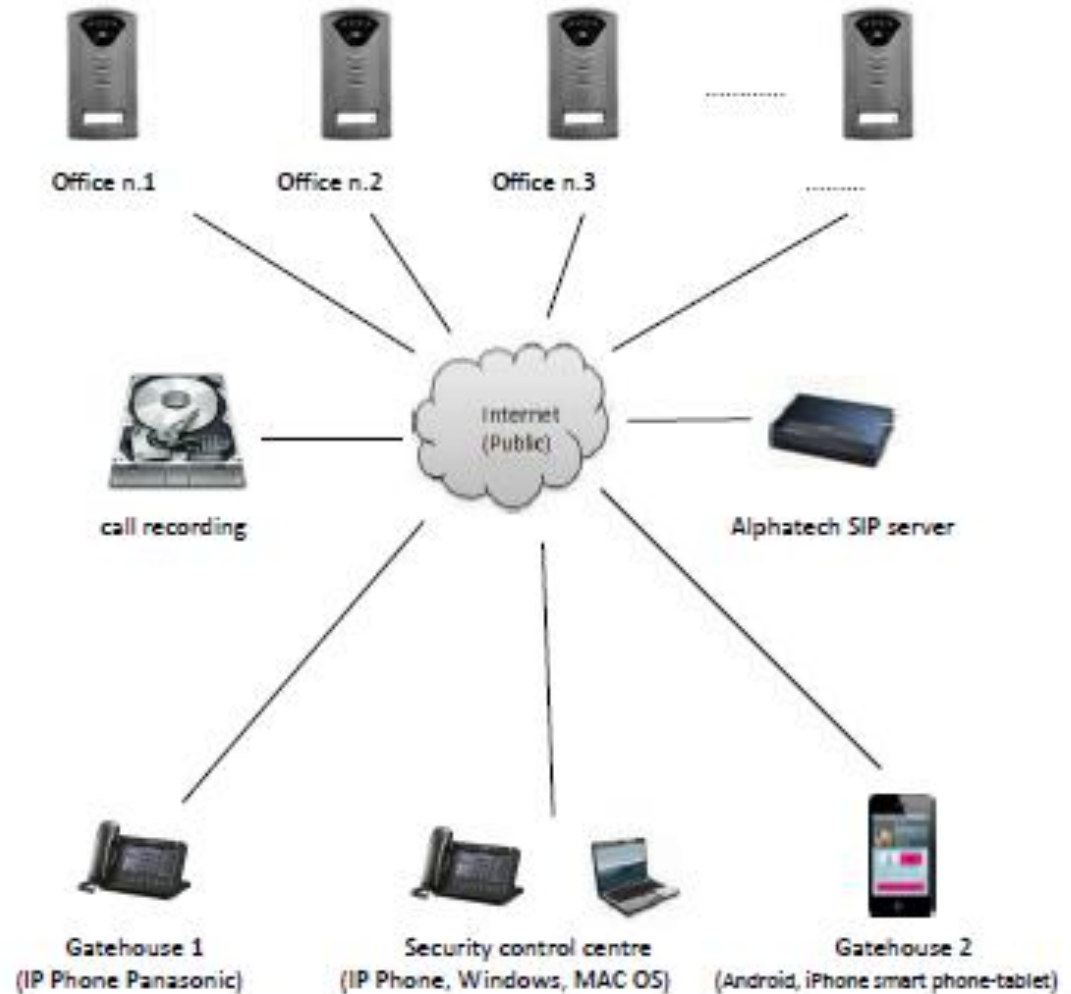

Alfacom IP video door entry security control system

customized voice messages of the IP video doorphone during busy or inaccessible phone line – when a visitor presses a push button of the IP video doorphone and the line is occupied or inaccessible, the IP video doorphone will play pre-recorded, predefined voice messages to the visitor.



Alfacom IP video door entry security control system

- automatic voice navigation – DISA messages – calls transferring based on the automated DISA voice tree.
- calls recording (text, voice, video) including a text message that the call was established, how long the call lasted, from which IP video doorphone to which phone line extension the call was made.

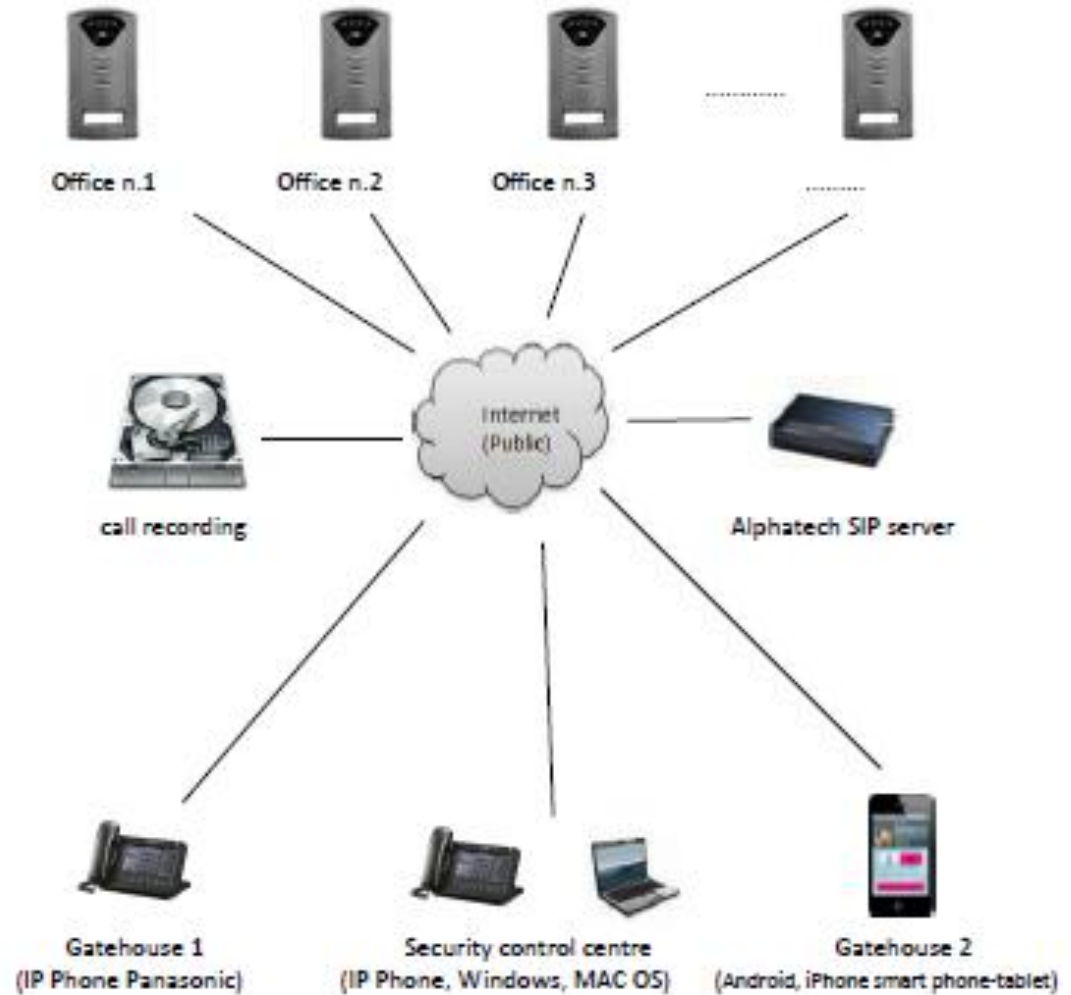

Alfacom IP video door entry security control system

- if a public SIP provider is used, the IP video doorphone can divert calls to any pre-programmed mobile phone number (a feature of an unlimited GSM router/gateway)
- NTP server with exact world time securing that all devices in the network are time synchronized

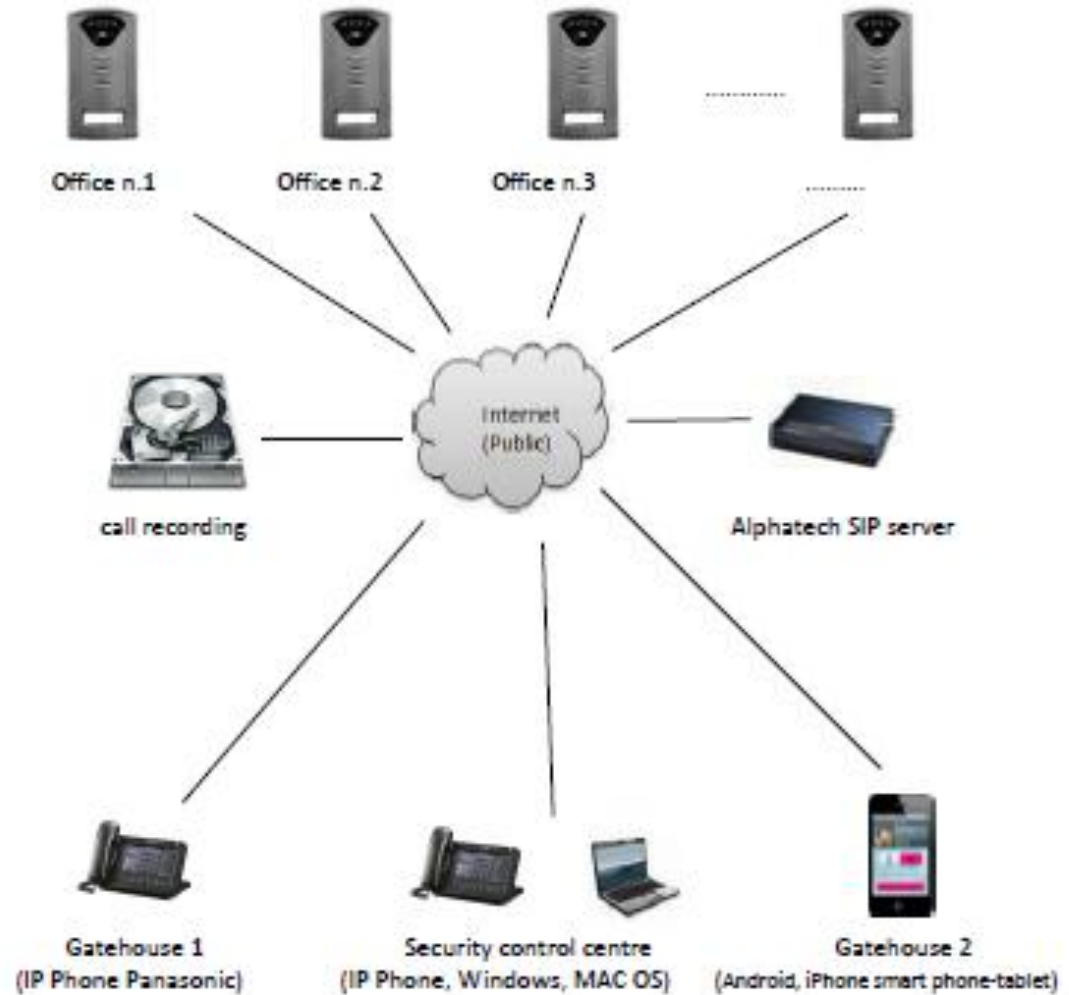

Alfacom IP video door entry security control system

- Panasonic HW IP video phones with a special, customized Alfacom (Android based) software for permanent transmission of a video stream from all cameras of all IP video doorphones. On the Panasonic IP video phone there can be a list of all door entrances (IP video doorphones) available, so you can select any specific door entry and view a continuous online video stream from any doorphone's camera at any time.

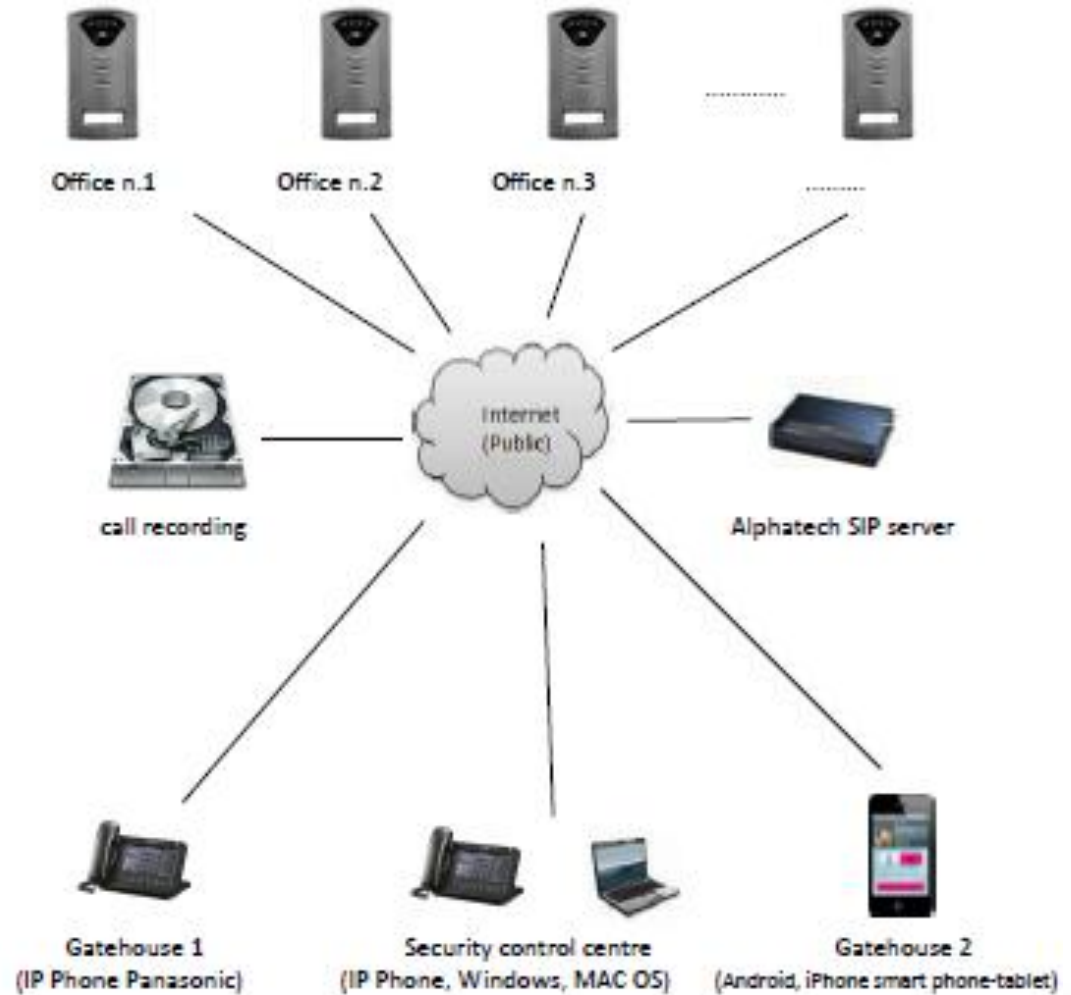

Alfacom lift/elevator and emergency communicators

- Overview of lift and emergency communicators
 - Emergency Communicators
 - Lift Solutions with a call center
 - PSTN
 - GSM
 - EN8182 compliant
 - References:
 - » OTIS
 - » KONE
 - ARM vandal proof communicator
 - PSTN or VoIP SIP
 - GSM
 - 1 or 3 buttons
 - IP55 certified



Alfacom lift/elevator and emergency communicators



- GSM Lift Watch – detailed information
- GSM equipment for wireless communication from the lift cabin
- Emergency voice connection of 1 or 2 lift cabins with
 - Emergency service
 - Fire brigade
 - Police
 - Assistance, etc.
- Remote settings and control via text messages (SMS)
 - Reset
 - Lift status, etc.

1001010111011101100010110101011010
0010111010100011011010100110100110110
11001010111001010100110101011110010100001101011

Alfacom lift/elevator and emergency communicators



- GSM Lift Watch
- Programming via PC
 - Well arranged work with all parameters.
 - Settings of numbers MASTER and TEST on the SIM card and checking of the numbers' format.
 - Settings of required text messages incl. numbers to which these text messages should be sent + checking of numbers' correct format.
 - GSM signal level/quality visual check.
 - Amount of credit on pre-paid SIM cards.
 - Downloading and storing of all parameters to PC for later use or as a back up copy.
 - Monitoring of communication with the GSM module(s) of the GSM Lift Watch unit.



Alfacom lift/elevator and emergency communicators

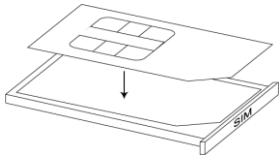

- GSM Lift Watch

- Start operation by inserting the SIM card into the SIM slot of the GSM Lift Watch unit.



001011101010001101101010011010011011011001010000110101100101011100101000011010110010101110010101101100010110101011010

Alfacom lift/elevator and emergency communicators

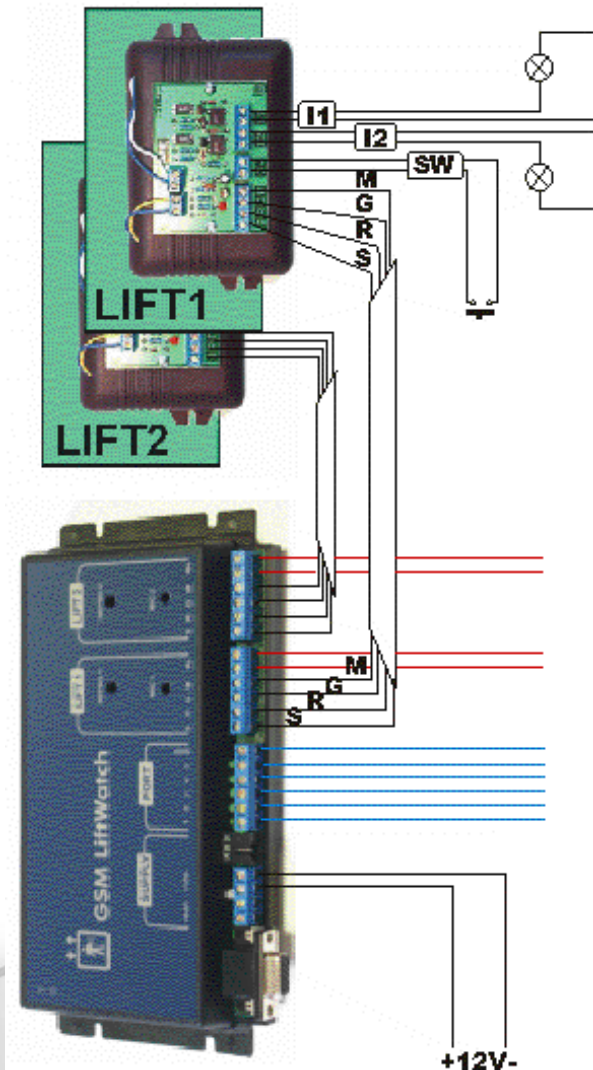

- GSM Lift Watch
- Basic wiring for 2 lift cabins
 - Powered from 12V lift power distribution
- After activation there is gradual calling up to 8 numbers on the SIM card
 - Automatic limitation of the call's length to 4 minutes
- Call back only from numbers stored on the SIM card
 - Other numbers are blocked
- Automatic test calls to one of the stored numbers
- Credit checking on pre-paid SIM cards
 - Notification in case of low credit to one of stored numbers.

1001010111011101100010110101011010
11011010100110100110100110110110
00101010100110101011110010100001101011

Alfacom lift/elevator and emergency communicators

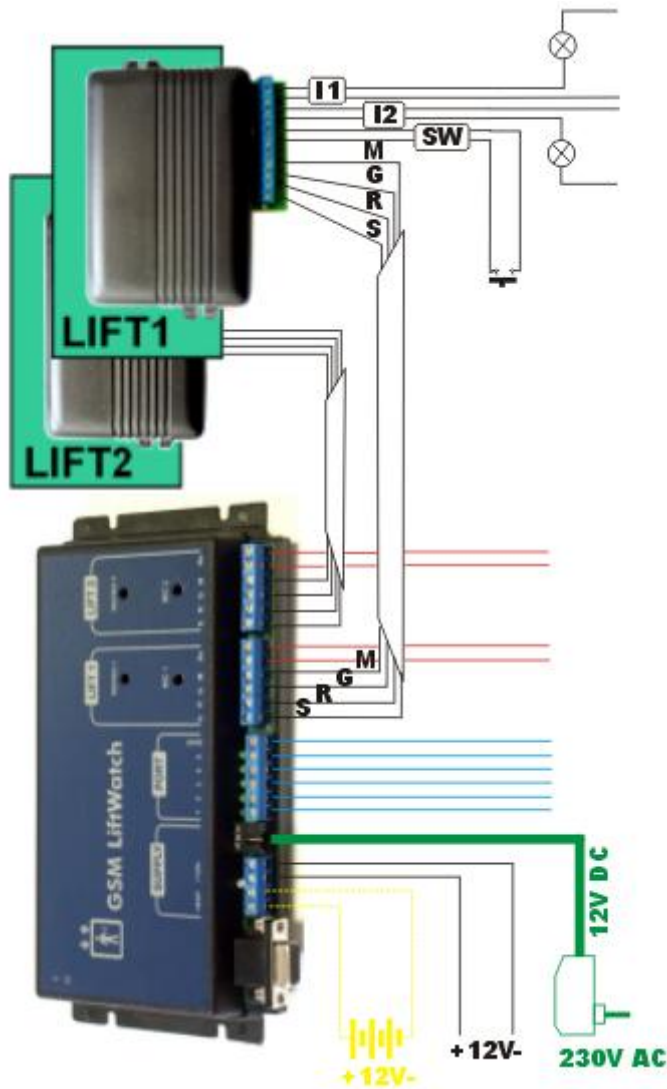

- GSM Lift Watch
- Possibility to connect to 230VAC via an adapter (optional).
- Back up can be done via 12V accu battery.

1001010111011101100010110101011010
1011010100110100110110
10101010011010101111001010000110101

Alfacom lift/elevator and emergency communicators

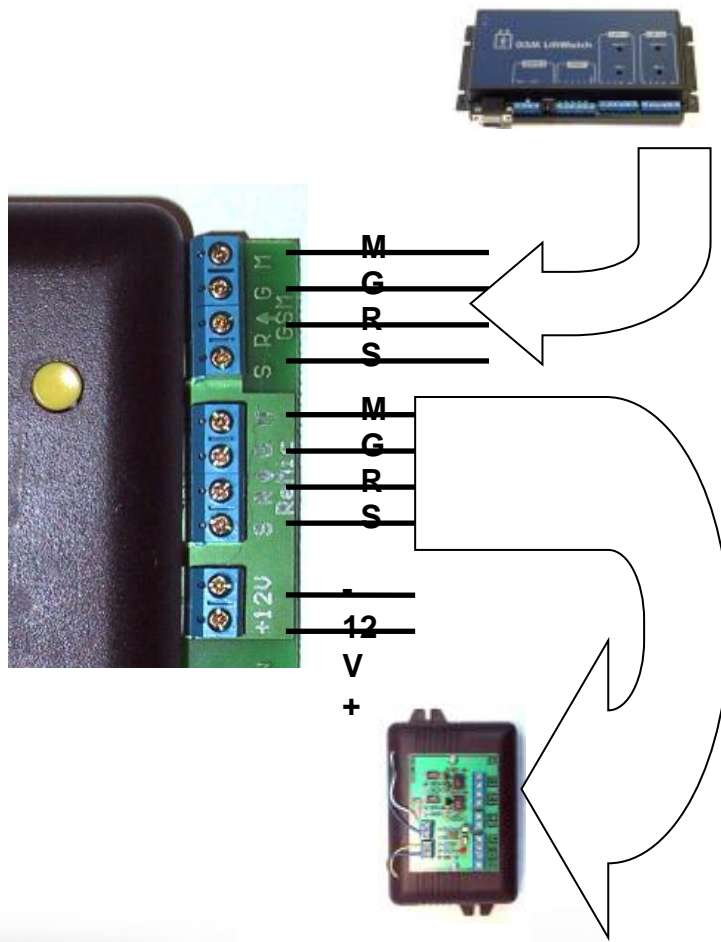

- GSM Lift Watch
- After pressing and holding the activation button the communication with the lift cabin is possible.
- Loudspeaker loudness regulation possibility
- Microphone loudness regulation possibility
- GSM Lift Watch Prepoj communication unit is used by installation and service engineers

001011 1010100011011010100110100110100110110
11001010111001010100110101011110010100001101011

Alfacom lift/elevator and emergency communicators

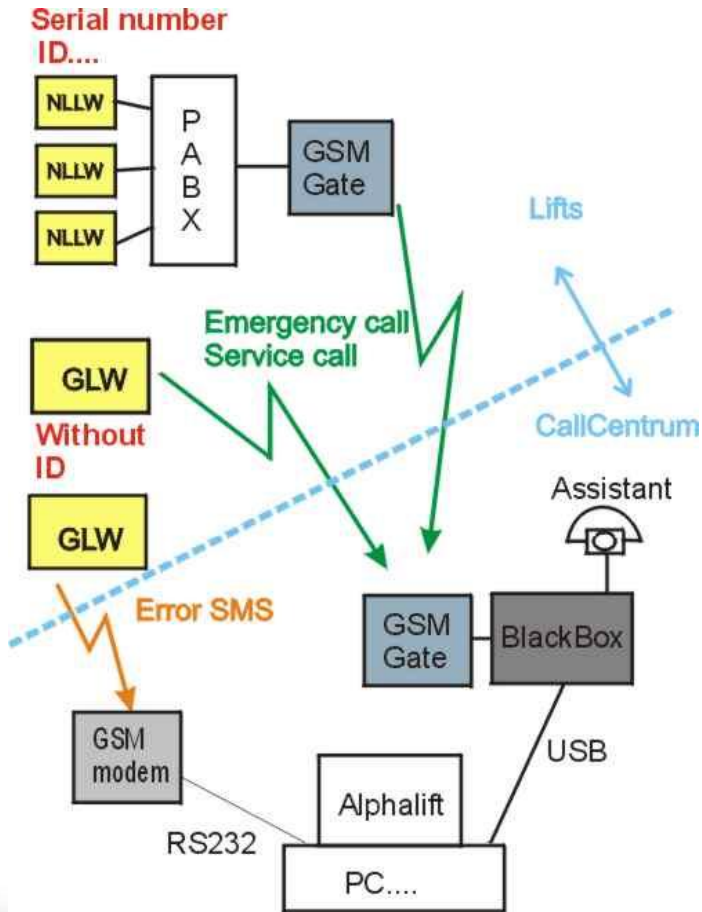

- GSM Lift Watch
- Call Center + BlackBox
 - automatic data collection
 - Receiving data from
 - GSM gateways/routers at lifts where PBXs and New Link Lift Watch units (NLLW) are used
 - GSM Lift Watch units (GLW)



Alfacom lift/elevator and emergency communicators

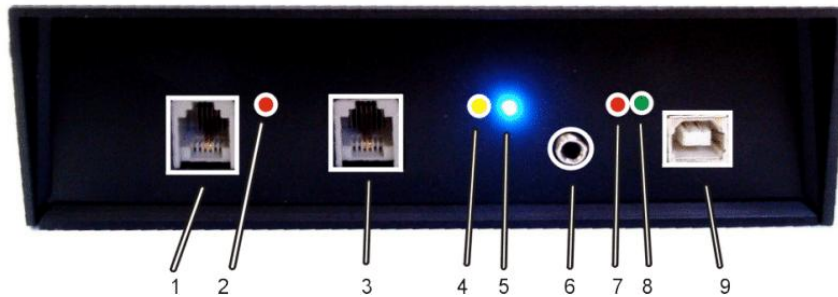

- GSM Lift Watch
- BlackBox and AlphaLift SW
 - Automatic data collection from lift communicators (New Link Lift Watch or GSM Lift Watch)
 - Processing of
 - Emergency calls
 - Service calls
 - USB connection to PC
 - Single-purpose SW called AlphaLift for automatic communication with lifts

1001010111011101100010110101011010
0010111010100011011010100110100110110
11001010111001010100110101011110010100001101011

Alfacom lift/elevator and emergency communicators

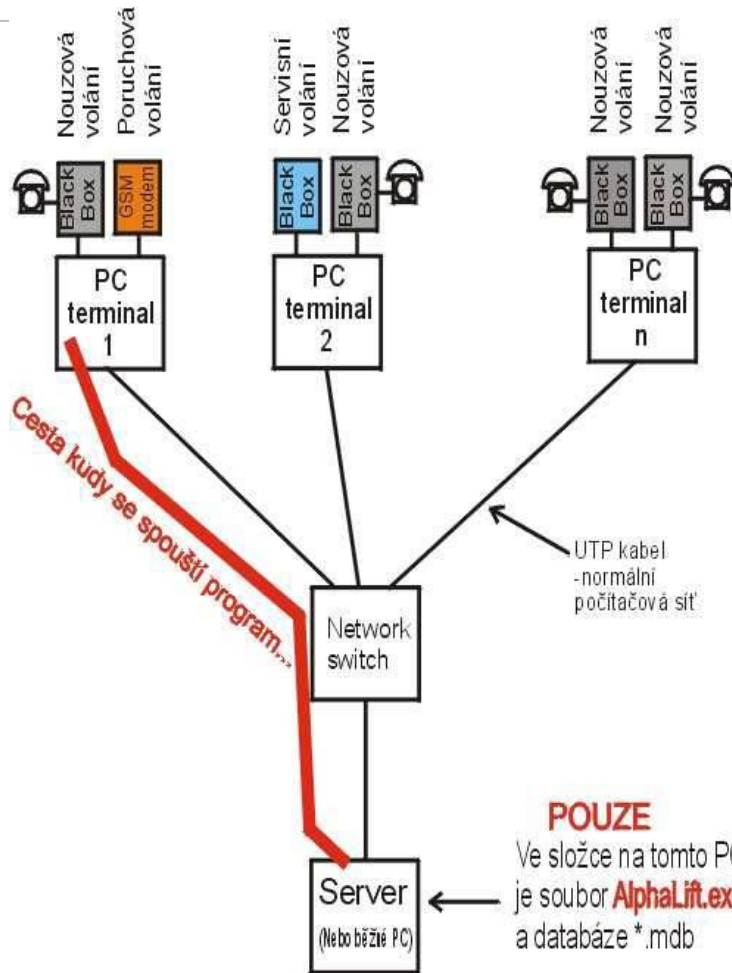

- GSM Lift Watch
- AlphaLift
 - SW for controlling the BlackBox in automatic mode
 - Single purpose application for identification of the type of call, where it is coming from, serial number of the calling unit.
 - Application used for recording to a protocol all calls from the lift cabins
 - Emergency calls (calls of persons blocked in the malfunctioning lift)
 - Service calls – automatic calls once in 3 days
 - Calls because of malfunctioning lift / lift out of order
 - Simple service and defect calls
 - Via text messages (SMS)

SMS-Mail server SW app

SMS-Mail is a SMTP and POP3 server which collaborates with Alfacom GSM gateways/routers.

It transforms SMS text messages into e-mails and e-mails into SMS text messages.

Components of SMS-Mail system :

- GSM gateway/router
- Data connection between GSM gateway and PC
- PC with Windows (NT, XP, Vista, 7, 8 ...) operational system
- SW program SMS_Mail
- Program for receiveing and sending e-mails (Outlook, Thunderbird ...)
- PC network (LAN)
- Other PCs with programs for receiveing and sending e-mails

What does it serve? What's the use of SMS-Mail?

- Exploits GSM gateway not only for calls but also for receiving and sending text SMS messages
- Integration of SMSs and e-mails into one system
- Easy way of sending and receiving bulk batches of SMSs
- Automatization
- Security

Who can use it?

- Companies and enterprises
- Municipal offices
- Firms sending offers and advertisements
- Any other users requiring sending/receiving text messages



Alfacom SMS_Mail server SW

Block schema of information processing in system

Sms-Mail as SMTP, POP3 server

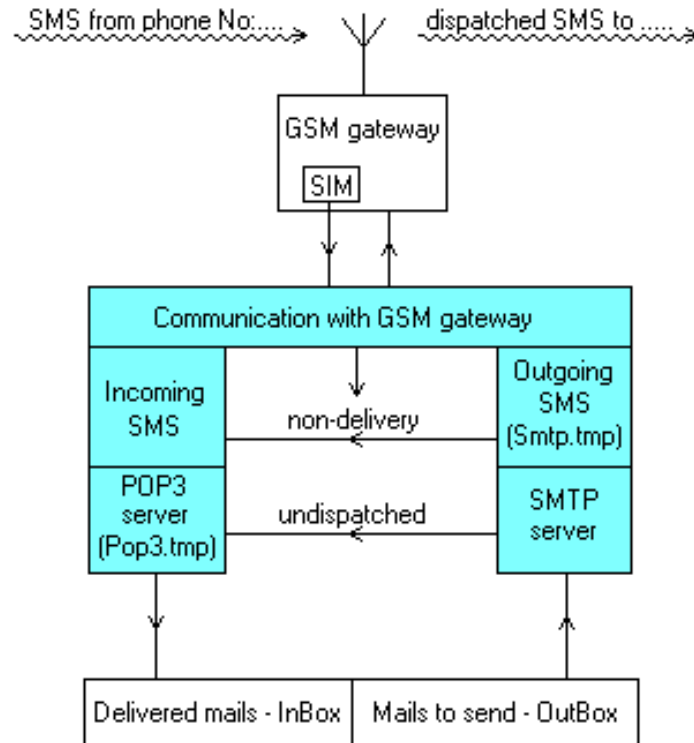

SMS Mail – connection of different systems

- SMS – short, simple text message
- Telephone number – the particular telephone
>>> x <<<
- E-mail body – universal container for data transfer
- E-mail address – e-mail client - program

Two different systems that are to be connected and data transferred.



SMS mail – connection with surroundings



- To GSM gateway – protocols for transfer of SMSs
 - Depends on type of gateway and way of connection



- To e-mail – SMTP and POP3 protocols
 - Server collaborating with e-mail clients
 - Adjusted for LAN net
 - Use of PC`s names in the net
 - Simplified communication regarding SMSs

1001010111011101100010110101011010

0010011000110101010100110110100001101011

What is e-mail client?

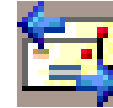

Program, which connects as a client to a SMTP and POP3 server – i.e. to the SMS-Mail program.

Types of e-mail clients, e.g.:

- Outlook express
- Windows Live Mail
- Outlook 2007, 2010...
- Thunderbird
- Etc...



Setting e-mail client



- For SMS-Mail, it is necessary to set an account in the client
- In the account, it is necessary to set SMTP and POP3 servers
- Address of the servers for work with SMSs is the address of the PC, in which SMS-Mail is running
- Other settings can be left unchanged or are not so important

SMS mail – internal inter-connection

Inter-connection of the section for SMSs with the section for e-mails

- Periodical data transfer between both sections
- Temporary data saving in files
- Common readable data format



Transfer e-mail -> SMS

- Detection whether it is possible to transfer e-mail into SMS
- Detection of telephone number
- Checking and adjusting of e-mail length
- Detection of charset and characters conversion
- Option to set time of sending



If any step fails, e-mail is returned to the sender



Example of transfer e-mail -> SMS

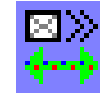

To whom - +123456789@smsmail.sms

E-mail body- simple text

- +123456789 – telephone number
- smsmail.sms – anything, what can pass through the program for mail sending (e-mail client)
- Simple text - is transferred to the shape for mobile phone

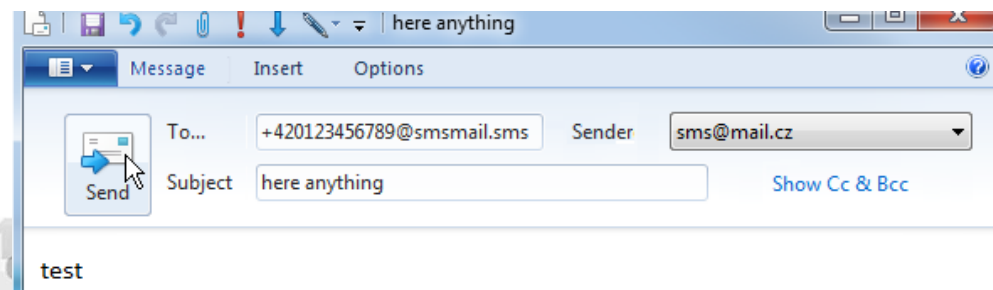

Transfer SMS -> e-mail

- Transfer of telephone number to e-mail address
- Transfer of SMS text to e-mail text
- Routing SMS to PCs in the net
 - Automatic – received by the sender
 - SMS routed to the particular PC
 - Option to deliver to all PCs or to just one PC
- Option of routing with an aid of PC aliases

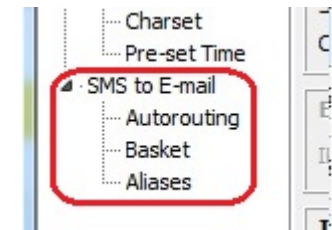

Example of transfer SMS -> e-mail

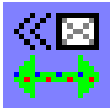
- Telephone number – identification of the sender
 - Text of SMS – any text
- 
- Telephone number is transferred to the shape `+123456789@smsmail.sms`
 - Received text of SMS is transferred to e-mail body.
 - E-mail is transmitted to the particular PC according to set routing rules.

Replacement address - telephone

- At receiving and sending e-mail, an ordinary e-mail address can be used
- Possible to define the table of relations e-mail address x telephone number
- If the replacement function is switched on
 - Possible to send SMS to e-mail address
 - Possible to receive SMS and to re-send it further using e-mail address instead of telephone number

Sending SMS without e-mail client

Window called from lower status bar

Main use:

- For program launching (start)
- For testing of communication with GSM gateway

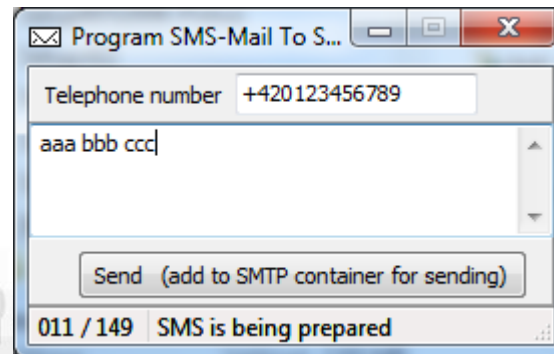

Check of e-mail clients

Window called from lower status bar

- Detection whether a client communicates
- Option to disconnect or switch off a client
- Detection when and who was connected last

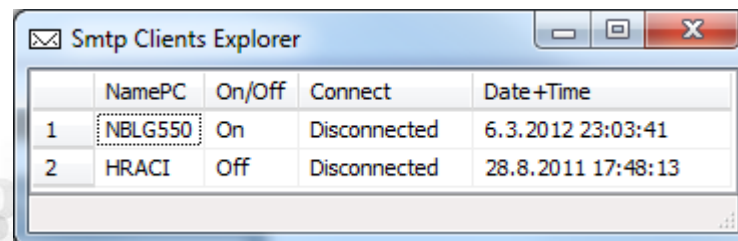

The screenshot shows a window titled "SmtP Clients Explorer" with a table containing the following data:

	NamePC	On/Off	Connect	Date+Time
1	NBLG550	On	Disconnected	6.3.2012 23:03:41
2	HRACI	Off	Disconnected	28.8.2011 17:48:13

Data buffers

File SMTP.tmp

- SMSs waiting for sending

File POP3.tmp

- SMSs waiting for release to e-mail clients

The files can be browsed by the program and are readable for text browsers.

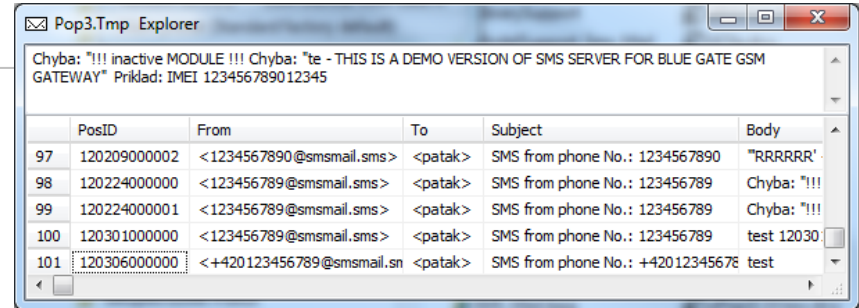

Chyba: "!!! inactive MODULE !!! Chyba: "te - THIS IS A DEMO VERSION OF SMS SERVER FOR BLUE GATE GSM GATEWAY" Příklad: IMEI 123456789012345

	PosID	From	To	Subject	Body
	97	120209000002 <1234567890@smsmail.sms>	<patak>	SMS from phone No.: 1234567890	"RRRRRR"
	98	120224000000 <123456789@smsmail.sms>	<patak>	SMS from phone No.: 123456789	Chyba: "!!!
	99	120224000001 <123456789@smsmail.sms>	<patak>	SMS from phone No.: 123456789	Chyba: "!!!
	100	120301000000 <123456789@smsmail.sms>	<patak>	SMS from phone No.: 123456789	test 12030
	101	120306000000 <+420123456789@smsmail.sn>	<patak>	SMS from phone No.: +42012345678	test

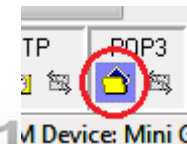

Storage of records

The program registers messages for check

- Received e-mails are saved also in the Sntp_YYMM.txt file
- Received SMSs are saved also in the Pop3_YYMM.txt file

YY – means year, MM – means month

Records are text, occupy one row and comprise date and time, telephone number and text.

Main program window

- Start, Stop and setting
- Actual information on program activity
- Status bar with icons
- Program version

